



LIST PRICE BOOK

June 15, 2022
REV-B



Value Added Freight Programs

Part of the Amtrol Advantage™

Amtrol has a variety of unique and flexible freight programs designed to fit the way you do business. From a low \$6,000 Full Freight Allowed (FFA) policy, to our Pallet Freight and Quick Ship (QS) programs, ordering from Amtrol has never been easier.

\$6,000 Full Freight Allowed (FFA): Any Mix of Products

- Any order attaining \$6,000 Net qualifies for FFA shipment.
- Combine Residential and Commercial products.
- Program applies to Wholesale customers for models in the US List Price Book.
- AK, HI destinations receive freight to the nearest port within the 48 contiguous states.
- Requests for partial shipments below \$6,000 are subject to prepay and add.

Pallet Freight Program: Ships in Three Days

- Full pallet quantities of Therm-X-Trol® ST-5 (75 ea.) and ST-12 (48 ea.), Therm-X-Span® T-5 (75 ea.) and T-12 (48 ea.) and Extrol® EX-15 (75 ea.) and EX-30 (48 ea.).
- Orders received by 12:00 PM EST ship FFA in three business days within the 48 contiguous states.



Quick Ship (QS) Program: Ships Next Day

- Select Well-X-Trol®, Therm-X-Trol, Therm-X-Span, Extrol, Fill-Trol®, BoilerMate® and HydroMax® models listed with QS next to the lead time will ship within one business day (no need to call to check inventory).
- Add 3% to order net and specify Quick Ship service.

Terms and Conditions

- All pricing and information contained within the Amtrol 2022 List Price Book is subject to Amtrol's Terms and Conditions. To access a complete copy of the Terms and Conditions, please visit www.amtrol.com.

Standard Leadtimes: Orders May Ship Early Unless Specified

- Standard leadtime is in working days.
- \$35,000 orders and above require a minimum 10-day standard leadtime.
- Longest model standard leadtime applies to entire order.
- Larger orders may be subject to longer leadtimes

All dimensions and weights listed are approximate.



Contents

RESIDENTIAL PRODUCTS

Air Purgers, Vents & Valves	13
AIR PURGERS.....	13
AIR VENTS.....	13
MIXING VALVES.....	13
TANK SERVICE CHECK VALVE.....	13
Expansion Tanks - Hydronic	12-13
EX-PRO MODELS: EXTROL® PRO NEXT GENERATION HYDRONIC EXPANSION TANKS, 7-Year Warranty.....	12
EX MODELS: EXTROL® INLINE BOILER SYSTEM EXPANSION TANKS, 7-Year Warranty	12
EX PACKAGES: EXTROL COMBINATION KITS, 7-Year Warranty.....	12
FT MODELS: FILL-TROL® TANKS AND AUTOMATIC FILL VALVES, 7-Year Warranty.....	12
FT PACKAGES: FILL-TROL COMBINATION KITS, 7-Year Warranty.....	12
SX MODELS: EXTROL VERTICAL BOILER SYSTEM EXPANSION TANKS, 1-Year Warranty	12
Expansion Tanks - Water Heater	10
ST MODELS: THERM-X-TROL® INLINE THERMAL EXPANSION TANKS, 7-Year Warranty.....	10
ST MODELS: THERM-X-TROL VERTICAL THERMAL EXPANSION TANKS.....	10
T MODELS: THERM-X-SPAN® INLINE THERMAL EXPANSION TANKS, 1-Year Warranty.....	10
Hot Water Makers®	14-15
BOILERMATE® INDIRECT-FIRED WATER HEATERS.....	14
HOT WATER MAKER REPLACEMENT PARTS.....	14
HYDROMAX® INDIRECT-FIRED WATER HEATERS.....	14
PREMIER HOT WATER STORAGE TANKS.....	15
PREMIER™ INDIRECT-FIRED WATER HEATERS.....	15
Pressure Boosters	9
Reverse Osmosis Storage Tanks	7
RO MODELS: REVERSE OSMOSIS STORAGE TANKS.....	7
Tube Straps & Hangers	11
Water Hammer Arrestors	10
WATER HAMMER ARRESTORS (SHOCK SUPPRESSORS).....	10
Well Tank Controls & Accessories	8
DIGITAL PRESSURE CONTROL.....	8
DURABASE® TANK SPACER.....	8
PUMP MOUNTING STAND.....	8
TOUCH-UP PAINT.....	8
Well Tanks, 125 PSI, 5-Year Warranty	6-7
CH MODELS: CHAMPION® VERTICAL STAND, DARK BLUE.....	6
WF MODELS: WEL-FLO® VERTICAL STAND, LIGHT GRAY.....	6
PL MODELS: PRO-LINE® VERTICAL STAND, TAN.....	7
Well-X1® System Well Tank & Digital Control	6
WX1 MODELS: READY-TO-RUN WITH GUARDIAN CP® DIGITAL PRESSURE CONTROL.....	6
Well-X-Trol® Well Tanks, 150 PSI, 7-Year Warranty	4-6
WX MODELS: VERTICAL STAND.....	4
WX MODELS: VERTICAL STAND WITH PRO ACCESS®.....	4
WX MODELS: HORIZONTAL WITH PUMP STAND.....	5
WX MODELS: INLINE.....	5
WX MODELS: VERTICAL WITH DURABASE® COMPOSITE STAND.....	5
WX MODELS: UNDERGROUND WITH SPECIAL UG COATING.....	6

COMMERCIAL PRODUCTS

Letters A-K denote product categories.

Prices and contents are subject to change without notice.

Visit www.amtrol.com to download the most current version of the List Price Book.

Air & Dirt Separators & Inline Air Purgers	22
AIR & DIRT SEPARATORS, ASME.....	22
INLINE AIR PURGERS.....	22
Air Separators	20
TANGENTIAL AIR SEPARATORS, LESS STRAINER, ASME.....	20
Air Separators & Purgers	21
TANGENTIAL AIR SEPARATORS, WITH STRAINER, ASME.....	21
Air Vents & Plain Steel Tanks	23
AC MODELS: PLAIN STEEL COMPRESSION TANKS, ASME.....	23
HIGH CAPACITY AIR VENT.....	23
Chilled Water Buffer Tanks	24
CWBT MODELS: CHILLED WATER BUFFER TANKS, ASME.....	24
Commercial Accessories	34
REPLACEMENT BLADDERS.....	34
Extrol® Bladder Tanks	18-19
L MODELS: FULL ACCEPTANCE BLADDER, TOP CONNECTION, ASME.....	18
LBC MODELS: PARTIAL ACCEPTANCE BLADDER, BOTTOM CONNECTION, ASME.....	19
Extrol® Diaphragm Tanks	16-17
AX MODELS: DEEP DRAWN DIAPHRAGM TYPE, ASME.....	16
AX MODELS: HEAD & SHELL DIAPHRAGM TYPE, ASME.....	16
AX-V MODELS: DEEP DRAWN DIAPHRAGM TYPE, ASME.....	17
AX-V MODELS: HEAD & SHELL DIAPHRAGM TYPE, ASME.....	17
Fire Protection Products	32
FPT MODELS: FIRE-X-TROL® SPRINKLER SYSTEM EXPANSION TANKS, 175 PSI, AMSE 32	
SPT MODELS: SURGE-TROL® SPRINKLER SYSTEM SURGE SUPPRESSORS, 275 PSI, ASME.....	32
Hot Water Buffer Tanks	25
HWBT MODELS: HOT WATER BUFFER TANKS, ASME.....	25
Shock Suppressors & Commercial Accessories	33
D MODELS: DIATROL® SHOCK SUPPRESSORS, 250 PSI, ASME.....	33
Therm-X-Trol® Bladder Tanks	27-28
ST-C Models: Full Acceptance Bladder, ASME.....	27
ST-CL Models: Partial Acceptance Bladder, ASME.....	28
Therm-X-Trol® Diaphragm Tanks	26
ST MODELS: DEEP DRAWN, DIAPHRAGM TYPE, ASME.....	26
ST MODELS: HEAD & SHELL, DIAPHRAGM TYPE, ASME.....	26
Well-X-Trol® Bladder Tanks	30-31
WX-C Models: Full Acceptance Bladder, ASME.....	30
WX-CL Models: Partial Acceptance Bladder, ASME.....	31
Well-X-Trol® Diaphragm Tanks	29
WX-C MODELS: DEEP DRAWN, DIAPHRAGM TYPE, ASME.....	29
WX-C MODELS: HEAD & SHELL, DIAPHRAGM TYPE, ASME.....	29
Index	35-37
Commercial Part Number Cross Reference Chart	38-43
Frequently Used Part Numbers	44-45
Quick Sizing	46
Warranty	47

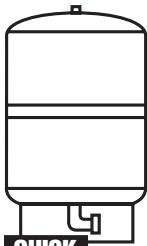
WX MODELS: VERTICAL STAND
A

QUICK SHIP ELIGIBLE

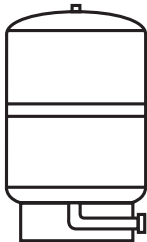
Model Number	Description	Part Number	Volume (Gal)	Max Acceptance Factor	Shipping Dimensions (In)			Shipping Weight (Lbs)	UPC 642031	Standard Leadtime (Days)	List Price (USD)
					L	W	H				
WX-201	BLUE	399579	14	0.81	15	15	25	25	644411	5	\$589.00
WX-202	BLUE	399585	20	0.57	15	15	32	32	644442	5 QS	\$723.00
WX-202XL	BLUE	399598	26	0.44	15	15	39	39	644503	5	\$763.00
WX-203	BLUE	399607	32	0.35	15	15	47	47	644572	5 QS	\$1,233.00
WX-205	BLUE	399616	34	1.00	22	22	30	57	644657	5 QS	\$1,349.00
WX-250	BLUE	399625	44	0.77	22	22	36	65	644718	5 QS	\$1,564.00
WX-251	BLUE	399635	62	0.55	22	22	47	87	644770	5 QS	\$1,849.00
WX-255	BLUE	399646	81	0.41	22	22	57	109	644862	5 QS	\$1,988.00
WX-302	BLUE	399655	86	0.54	26	26	47	106	644947	5 QS	\$2,195.00
WX-350	BLUE	399664	119	0.39	26	26	62	146	645005	5 QS	\$3,125.00
WX-201-T	TAN	399584	14	0.81	15	15	25	25	645081	5	\$589.00
WX-202-T	TAN	399596	20	0.57	15	15	32	32	644459	5	\$723.00
WX-202XL-T	TAN	399606	26	0.44	15	15	39	39	644510	5	\$763.00
WX-203-T	TAN	399615	32	0.35	15	15	47	47	644589	5	\$1,233.00
WX-205-T	TAN	399624	34	1.00	22	22	30	57	644664	5	\$1,349.00
WX-250-T	TAN	399633	44	0.77	22	22	36	65	644725	5	\$1,564.00
WX-251-T	TAN	399643	62	0.55	22	22	47	87	644787	5	\$1,849.00
WX-255-T	TAN	399654	81	0.41	22	22	57	109	644879	5	\$1,988.00
WX-302-T	TAN	399663	86	0.54	26	26	47	106	644954	5	\$2,195.00
WX-350-T	TAN	399672	119	0.39	26	26	62	146	645012	5	\$3,125.00
WX-201-G	GRAY	399583	14	0.81	15	15	25	25	650634	5	\$589.00
WX-202-G	GRAY	399590	20	0.57	15	15	32	32	646132	5	\$723.00
WX-202XL-G	GRAY	399602	26	0.44	15	15	39	39	646149	5	\$763.00
WX-203-G	GRAY	399611	32	0.35	15	15	47	47	646156	5	\$1,233.00
WX-205-G	GRAY	399620	34	1.00	22	22	30	57	646163	5	\$1,349.00
WX-250-G	GRAY	399629	44	0.77	22	22	36	65	646170	5	\$1,564.00
WX-251-G	GRAY	399639	62	0.55	22	22	47	87	646187	5	\$1,849.00
WX-255-G	GRAY	399650	81	0.41	22	22	57	109	646194	5	\$1,988.00
WX-302-G	GRAY	399659	86	0.54	26	26	47	106	646200	5	\$2,195.00
WX-350-G	GRAY	399668	119	0.39	26	26	62	146	646217	5	\$3,125.00

WX MODELS: VERTICAL STAND WITH PRO ACCESS®
A

WX-202PA	BLUE	399592	20	0.57	15	15	32	33	644473	5	\$794.00
WX-202XLPA	BLUE	399603	26	0.44	15	15	39	40	644541	5	\$834.00
WX-203PA	BLUE	399612	32	0.35	15	15	47	48	644602	5	\$1,303.00
WX-205PA	BLUE	399621	34	1.00	22	22	30	59	644688	5	\$1,477.00
WX-250PA	BLUE	399630	44	0.77	22	22	36	67	644749	5	\$1,691.00
WX-251PA	BLUE	399640	62	0.55	22	22	47	88	644800	5	\$1,976.00
WX-255PA	BLUE	399651	81	0.41	22	22	57	111	644893	5	\$2,114.00
WX-302PA	BLUE	399660	86	0.54	26	26	47	108	644978	5	\$2,322.00
WX-350PA	BLUE	399669	119	0.39	26	26	62	148	645036	5	\$3,253.00
WX-202PA-T	TAN	399594	20	0.57	15	15	32	33	644480	5	\$794.00
WX-202XLPA-T	TAN	399605	26	0.44	15	15	39	40	644558	5	\$834.00
WX-203PA-T	TAN	399614	32	0.35	15	15	47	48	644619	5	\$1,303.00
WX-205PA-T	TAN	399623	34	1.00	22	22	30	59	644695	5	\$1,477.00
WX-250PA-T	TAN	399632	44	0.77	22	22	36	67	644756	5	\$1,691.00
WX-251PA-T	TAN	399642	62	0.55	22	22	47	88	644817	5	\$1,976.00
WX-255PA-T	TAN	399653	81	0.41	22	22	57	111	644909	5	\$2,114.00
WX-302PA-T	TAN	399662	86	0.54	26	26	47	108	644985	5	\$2,322.00
WX-350PA-T	TAN	400808	119	0.39	26	26	62	148	645043	5	\$3,253.00
WX-202PA-G	GRAY	399593	20	0.57	15	15	32	33	646224	5	\$794.00
WX-202XLPA-G	GRAY	399604	26	0.44	15	15	39	40	646231	5	\$834.00
WX-203PA-G	GRAY	399613	32	0.35	15	15	47	48	646248	5	\$1,303.00
WX-205PA-G	GRAY	399622	34	1.00	22	22	30	59	646255	5	\$1,477.00
WX-250PA-G	GRAY	399631	44	0.77	22	22	36	67	646262	5	\$1,691.00
WX-251PA-G	GRAY	399641	62	0.55	22	22	47	88	646279	5	\$1,976.00
WX-255PA-G	GRAY	399652	81	0.41	22	22	57	111	646286	5	\$2,114.00
WX-302PA-G	GRAY	399661	86	0.54	26	26	47	108	646293	5	\$2,322.00
WX-350PA-G	GRAY	399670	119	0.39	26	26	62	148	646309	5	\$3,253.00

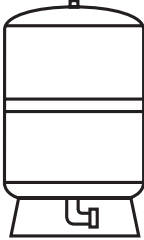
WX MODELS: VERTICAL WITH DURABASE® COMPOSITE STAND A

Model Number	Description	Part Number	Volume (Gal)	Max Acceptance Factor	Shipping Dimensions (In)			Shipping Weight (Lbs)	UPC 642031	Standard Leadtime (Days)	List Price (USD)	
					L	W	H					
	WX-201D	BLUE	399580	14	0.81	15	15	25	25	645159	5	\$659.00
	WX-202D	BLUE	399587	20	0.57	15	15	32	32	645173	5	\$794.00
	WX-202XLD	BLUE	399599	26	0.44	15	15	39	39	645210	5	\$834.00
	WX-203D	BLUE	399608	32	0.35	15	15	47	47	645241	5	\$1,303.00
	WX-205D	BLUE	399617	34	1.00	22	22	30	57	645289	5	\$1,477.00
	WX-250D	BLUE	399626	44	0.77	22	22	36	65	645319	5	\$1,691.00
	WX-251D	BLUE	399636	62	0.55	22	22	47	87	645340	5	\$1,976.00
	WX-255D	BLUE	399647	81	0.41	22	22	57	109	645371	5	\$2,114.00
	WX-302D	BLUE	399656	86	0.54	26	26	47	106	645418	5	\$2,322.00
	WX-350D	BLUE	399665	119	0.39	26	26	62	146	645449	5	\$3,253.00
	WX-201D-T	TAN	399582	14	0.81	15	15	25	25	645166	5	\$659.00
	WX-202D-T	TAN	399589	20	0.57	15	15	32	32	645197	5	\$794.00
	WX-202XLD-T	TAN	N/A	26	0.44	15	15	39	39	645227	5	\$834.00
	WX-203D-T	TAN	399610	32	0.35	15	15	47	47	645258	5	\$1,303.00
	WX-205D-T	TAN	399619	34	1.00	22	22	30	57	645296	5	\$1,477.00
WX-250D-T	TAN	399628	44	0.77	22	22	36	65	645326	5	\$1,691.00	
WX-251D-T	TAN	399638	62	0.55	22	22	47	87	645357	5	\$1,976.00	
WX-255D-T	TAN	399649	81	0.41	22	22	57	109	645388	5	\$2,114.00	
WX-302D-T	TAN	399658	86	0.54	26	26	47	106	645425	5	\$2,322.00	
WX-350D-T	TAN	399667	119	0.39	26	26	62	146	645456	5	\$3,253.00	
WX-201D-G	GRAY	399581	14	0.81	15	15	25	25	648686	5	\$659.00	
WX-202D-G	GRAY	399588	20	0.57	15	15	32	32	648693	5	\$794.00	
WX-202XLD-G	GRAY	399600	26	0.44	15	15	39	39	648709	5	\$834.00	
WX-203D-G	GRAY	399609	32	0.35	15	15	47	47	648716	5	\$1,303.00	
WX-205D-G	GRAY	399618	34	1.00	22	22	30	57	648723	5	\$1,477.00	
WX-250D-G	GRAY	399627	44	0.77	22	22	36	65	648730	5	\$1,691.00	
WX-251D-G	GRAY	399637	62	0.55	22	22	47	87	648747	5	\$1,976.00	
WX-255D-G	GRAY	399648	81	0.41	22	22	57	109	648754	5	\$2,114.00	
WX-302D-G	GRAY	399657	86	0.54	26	26	47	106	648761	5	\$2,322.00	
WX-350D-G	GRAY	399666	119	0.39	26	26	62	146	648778	5	\$3,253.00	

WX MODELS: INLINE A

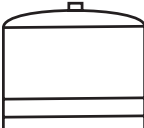
	WX-101	BLUE	399557	2.0	0.45	8	8	13	5	644053	5 QS	\$185.00
	WX-102	BLUE	399559	4.4	0.55	11	11	15	9	644084	5 QS	\$255.00
	WX-103	BLUE	399565	6.7	0.40	11	11	20	13	644114	5 QS	\$413.00
	WX-104	BLUE	399568	10.3	1.00	15	15	18	20	644145	5	\$461.00
	WX-200	BLUE	399575	14.0	0.81	15	15	22	22	644169	5	\$488.00

QUICK SHIP ELIGIBLE

WX MODELS: HORIZONTAL WITH PUMP STAND A

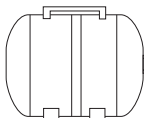
	WX-102PS	BLUE	399561	4.4	0.55	15	11	12	13	644190	5	\$384.00
	WX-110PS	BLUE	399571	7.4	0.56	23	11	12	18	649102	5	\$505.00
	WX-200PS	BLUE	399577	14.0	0.81	22	15	16	29	644268	5	\$878.00
	WX-202PS	BLUE	399595	20.0	0.57	30	15	16	35	649119	5	\$1,100.00
	WX-202H	BLUE*	399591	20.0	0.57	30	15	16	33	644299	5	\$775.00

*W/O PUMP STAND

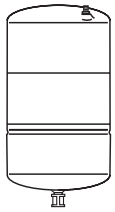
WX MODELS: UNDERGROUND WITH SPECIAL UG COATING
A

Model Number	Description	Part Number	Volume (Gal)	Max Acceptance Factor	Shipping Dimensions (In)			Shipping Weight (Lbs)	UPC 642031	Standard Leadtime (Days)	List Price (USD)
					L	W	H				
WX-200UG		399578	14	0.81	15	15	23	22	644312	10	\$747.00
WX-202UG		399597	20	0.57	15	15	30	30	644336	10	\$1,077.00
WX-250UG		399634	44	0.77	22	22	33	60	644367	10	\$2,089.00
WX-251UG		399644	62	0.55	22	22	44	83	644381	10	\$2,483.00

Well-X1® System Well Tank & Digital Control

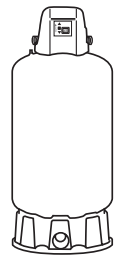
WX1 MODELS: READY-TO-RUN WITH GUARDIAN CP® DIGITAL PRESSURE CONTROL
A

WX1-250D	BLUE	399572	44	0.77	22	22	44	80	650238	10	\$2,439.00
WX1-251D	BLUE	399573	62	0.55	22	22	55	103	650221	10	\$2,724.00
WX1-302D	BLUE	399574	86	0.54	26	26	55	134	650214	10	\$3,073.00



Pallet Quantity: WX-101: 75, WX-102: 48, WX-103: 32, WX-104 & WX-200: 18
 WX-102-PS: 32, WX-110PS: 32, WX-200-PS: 18, WX-202PS: 18
 WX-200UG & WX-202UG: 18, WX-250UG & WX-251UG: 4
 WX-201 and WX-202: 18, WX-202XL & WX-203: 9, WX-205 through WX-350: 4

Connection: Stainless Steel: WX-101 through WX-103, WX-102PS through WX-110PS: 3/4" NPTM, WX-104, WX-200, WX-200PS, WX-202PS and WX-202H: 1" NPTM, WX-200UG, WX-202UG and WX-201 through WX-203: 1" NPTF, WX-205 through WX-350, WX250UG and WX-251UG: 1-1/4" NPTF

Factory Precharge: All WX and WX1 Models: 38 PSI
Working Pressure: All WX and WX1 Models: 150 PSI
Warranty: All WX Models: 7-Year Limited; WX1: 7-Year Limited (Tank), 2-Year Limited (Control).

Well Tanks, 125 PSI, 5-Year Warranty

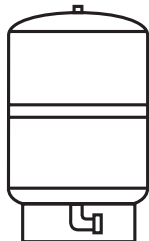
CH MODELS: CHAMPION® VERTICAL STAND, DARK BLUE
A

Model Number	Description	Part Number	Volume (Gal)	Max Acceptance Factor	Shipping Dimensions (In)			Shipping Weight (Lbs)	UPC 642031	Standard Leadtime (Days)	List Price (USD)
					L	W	H				
CH-14	CH3001	399346	14	0.81	15	15	25	24	530295	10	\$539.00
CH-20	CH4202	399348	20	0.57	15	15	32	30	529329	10	\$702.00
CH-26	CH6000	399351	26	0.44	15	15	39	37	550798	10	\$745.00
CH-32	CH8003	399352	32	0.35	15	15	47	43	530318	10	\$1,200.00
CH-34	CH8205	399355	34	1.00	22	22	30	50	530332	10	\$1,314.00
CH-44	CH10050	399332	44	0.77	22	22	36	57	530257	10	\$1,518.00
CH-62	CH12051	399335	62	0.55	22	22	47	75	530264	10	\$1,790.00
CH-81	CH17255	399340	81	0.41	22	22	57	92	550705	10	\$1,926.00
CH-86	CH17002	399336	86	0.54	26	26	47	99	530271	10	\$2,130.00
CH-119	CH22050	399343	119	0.39	26	26	62	133	530288	10	\$3,034.00

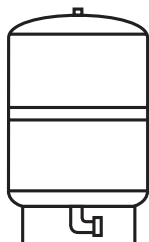
WF MODELS: WEL-FLO® VERTICAL STAND, LIGHT GRAY
A

WF-14	WF45	399495	14	0.81	15	15	25	24	406736	10	\$539.00
WF-20	WF60	399497	20	0.57	15	15	32	30	406767	10	\$702.00
WF-26	WF80	399499	26	0.44	15	15	39	37	550828	10	\$745.00
WF-32	WF100	399479	32	0.35	15	15	47	43	406620	10	\$1,200.00
WF-34	WF110	399481	34	1.00	22	22	30	50	406637	10	\$1,314.00
WF-44	WF140	399483	44	0.77	22	22	36	57	406651	10	\$1,518.00
WF-62	WF200	399485	62	0.55	22	22	47	75	406675	10	\$1,790.00
WF-81	WF255	399489	81	0.41	22	22	57	92	550675	10	\$1,926.00
WF-86	WF260	399491	86	0.54	26	26	47	99	406699	10	\$2,130.00
WF-119	WF360	399493	119	0.39	26	26	62	133	406705	10	\$3,034.00

PL MODELS: PRO-LINE® VERTICAL STAND, TAN A

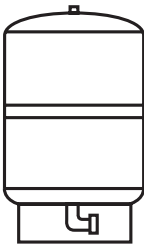
Model Number	Part Number	Volume (Gal)	Max Acceptance Factor	Shipping Dimensions (In)			Shipping Weight (Lbs)	UPC 642031	Standard Leadtime (Days)	List Price (USD)	
				L	W	H					
	PL-14	399325	14	0.81	15	15	25	22	409935	10	\$539.00
	PL-20	399326	20	0.57	15	15	32	28	409942	10	\$702.00
	PL-26	399328	26	0.44	15	15	39	34	550804	10	\$745.00
	PL-32	399329	32	0.35	15	15	47	40	409959	10	\$1,200.00
	PL-34	399330	34	1.00	22	22	30	50	400024	10	\$1,314.00
	PL-44	399319	44	0.77	22	22	36	57	399984	10	\$1,518.00
	PL-62	399320	62	0.55	22	22	47	75	399991	10	\$1,790.00
	PL-81	399323	81	0.41	22	22	57	92	550712	10	\$1,926.00
	PL-86	399321 (SHORT)	86	0.54	26	26	47	99	660008	10	\$2,130.00
	PL-119	399324	119	0.39	26	26	62	133	400017	10	\$3,034.00



Pallet Quantity: 14 & 20 Gal: 18, 26 & 32 Gal: 9, 34 through 119 Gal: 4
Connection: Stainless Steel: 14 through 32 Gal: 1" NPTF, 34 through 119 Gal: 1-1/4" NPTF
Factory Precharge: All CH, WF & PL Models: 38 PSI
Working Pressure: CH, WF & PL: 125 PSI
Warranty: All CH, WF & PL Models: 5-Year Limited



Reverse Osmosis Storage Tanks

RO MODELS: REVERSE OSMOSIS STORAGE TANKS A

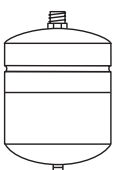
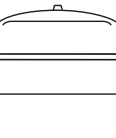
Model Number	Color	Part Number	PSI	Other	Total Volume (Gal)	Connection Size (In)	Shipping Weight (Lbs)	UPC 642031	Standard Leadtime* (Days)	List Price (USD)	
	RO-4	BLUE	390757	5 PSI	PLASTIC STAND	4	1/4	9	462862	10	\$412.00
	RO-4	WHITE	390758	5 PSI	PLASTIC STAND	4	1/4	9	462879	10	\$412.00
	RO-10	BLUE	398933	5 PSI	PLASTIC STAND	10	3/4	20	129116	10	\$784.00
	RO-14	BLUE	398935	15 PSI	SHORT STAND	14	3/4	24	129710	10	\$840.00
	RO-14	BLUE	398937	15 PSI	STEEL STAND	14	1/4	24	391490	10	\$840.00
	RO-20PA	BLUE	398955	15 PSI	PRO ACCESS® CONN	20	3/4	32	563026	10	\$1,014.00
	RO-20	BLUE	398948	15 PSI	STEEL STAND	20	3/4	32	130716	10	\$946.00
	RO-34PA	BLUE	391340	15 PSI	PRO ACCESS CONN	34	1-1/4	61	563033	10	\$1,898.00
	RO-34	BLUE	391372	15 PSI	STEEL STAND	34	1-1/4	61	138293	10	\$1,776.00
	RO-44PA	BLUE	391341	15 PSI	PRO ACCESS CONN	44	1-1/4	86	563040	10	\$2,052.00
	RO-44	BLUE	391374	15 PSI	STEEL STAND	44	1-1/4	86	138422	10	\$1,899.00
	RO-86PA	BLUE	391579	15 PSI	PRO ACCESS CONN	86	1-1/4	123	563057	10	\$3,074.00
	RO-86	BLUE	391575	15 PSI	STEEL STAND	86	1-1/4	123	139931	10	\$2,882.00
	RO-119PA	BLUE	391617	15 PSI	PRO ACCESS CONN	119	1-1/4	166	563064	10	\$4,380.00

*Order quantities over 100 each require a 30 day lead time

RO-2 THROUGH RO-10

RO-14 (398935)

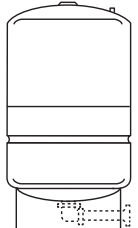

RO-14 (398937) THROUGH RO-119



Pallet Quantity: RO-2: 75, RO-4: 48, RO-10 through 20: 18, RO-34 through 119: 4
Connection: Stainless Steel
Warranty: 5-Year Limited

DIGITAL PRESSURE CONTROL

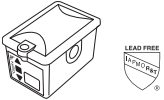
Part Number	Description	Shipping Dimensions (In)			Shipping Weight (Lbs)	UPC 642031	Standard Leadtime (Days)	List Price (USD)
		L	W	H				
	398987 GUARDIAN CP®	4	8	4	2	639889	1	\$385.00
	391218 EXTERNAL GROUNDING KIT	2	2	2	1	638748	5	\$128.00

DURABASE® TANK SPACER

	437409 FITS AMTROL 15" STEEL STAND MODELS	16	16	6	2	648433	5	\$34.30
	397530 FITS AMTROL 22" & 26" STEEL STAND MODELS	23	23	7	3	648440	5	\$57.20

PUMP MOUNTING STAND

	398096 UNIVERSAL VERTICAL TANKS	8	10	3	3	049708018405	5	\$86.50
---	---------------------------------	---	----	---	---	--------------	---	---------

TOUCH-UP PAINT

390457	WELL-X-TROL® BLUE 4.5 OZ SPRAY	2	2	4	1	121486	5	\$47.60
--------	--------------------------------	---	---	---	---	--------	---	---------

Warranty: Guardian CP: 2-Year Limited, All Well Tank Accessories: 1-Year Limited

RP MODELS: AMTROL PRESSURISER® CITY WATER PRESSURE BOOSTER SYSTEMS

D

Part Number	Model Number/Description	Volume (Gal)	Shipping Dimensions (In)			Shipping Weight (Lbs)	UPC 642031	Standard Leadtime (Days)	List Price (USD)
			L	W	H				
392907	RP-10HP / 10 GPM SYSTEM	14	17	17	30	50	574732	10	\$2,580.00
392908	RP-15HP / 15 GPM SYSTEM	20	17	17	38	55	574886	10	\$2,767.00
392906	RP-25HP / 25 GPM SYSTEM	34	22	22	39	90	499295	10	\$4,063.00

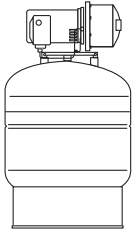

HP SERIES BOOSTER SYSTEM REPLACEMENT PARTS

I

392917	245-59 / PUMP RP-10HP					23	593467	1	\$1,861.00
392918	245-60 / PUMP RP-15HP					23	593474	1	\$1,861.00
392919	245-61 / PUMP RP-25HP					23	593481	1	\$1,861.00
392915	2201R37 / TANK RP-10, 14 Gal					25	618634	1	\$1,271.00
392916	2201R39 / TANK RP-15, 20 Gal					33	618658	1	\$1,319.00
392914	2201R28 / TANK RP-25, 34 Gal					61	618719	1	\$1,740.00
399919	2201N002 / SHAFT SEAL KIT - All Models					1	447371	1	\$62.00
399920	2201N003 / IMPELLER RP-10					1	447418	1	\$208.00
399921	2201N020 / IMPELLER RP-15					1	447425	1	\$179.00
399922	2201N021 / IMPELLER RP-25					1	447432	1	\$194.00
392912	2201N006 / O-RING REBUILD KIT - All Models					1	447401	1	\$152.00
392913	2201N010 / PUMP VENTURI - All Models					1	466655	1	\$136.00
399923	2201N022 / PUMP GUIDE VANE - All Models					1	447449	1	\$118.00
389815	113-3 / GUARDIAN CP® UPGRADE KIT					2	645654	1	\$706.00
398987	146-832 / GUARDIAN CP DIGITAL PRESSURE CONTROL					2	639899	1	\$385.00



Pallet Quantity: RP-10HP through RP-25HP: 4
Connection: Stainless Steel: RP-10HP through RP-25HP: 1-1/4" NPTF In, 1" NPTF Out
Warranty: RP-10HP through RP-25HP: 2-Year Limited, Guardian CP: 2-Year Limited, All Replacement Parts: 1 Year Limited

ST MODELS: THERM-X-TROL® INLINE THERMAL EXPANSION TANKS, 7-Year Warranty

B

Model Number	Description	Part Number	Volume (Gal)	Max Acceptance Volume (Gal)	Shipping Dimensions (In)			Shipping Weight (Lbs)	UPC 642031	Standard Leadtime (Days)	List Price (USD)
					L	W	H				
 ST-1	MATTE TAN	398917	—	—	3.4	3.4	4	1	679932	10	\$48.70
ST-5	HIGH-GLOSS TAN	390570	2.0	0.9	8	8	13	5	395665	5 QS	\$123.00
ST-12	HIGH-GLOSS TAN	390748	4.4	3.2	11	11	15	9	395672	5 QS	\$165.00



QUICK SHIP ELIGIBLE

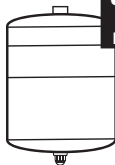

ST MODELS: THERM-X-TROL VERTICAL THERMAL EXPANSION TANKS, 1-Year Warranty

B

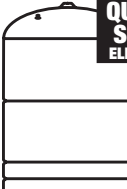
Model Number	Description	Part Number	Volume (Gal)	Max Acceptance Volume (Gal)	Shipping Dimensions (In)			Shipping Weight (Lbs)	UPC 642031	Standard Leadtime (Days)	List Price (USD)
					L	W	H				
 ST-25V	TAN	390935	10.3	10.3	15	15	19	23	395689	5 QS	\$503.00
ST-30V	TAN	390936	14.0	11.3	15	15	24	25	395696	5	\$616.00
ST-42V	TAN	391061	20.0	11.4	15	15	32	33	395702	5	\$734.00
ST-60V	TAN	391429	34.0	34.0	22	22	30	61	395719	5	\$948.00
ST-80V	TAN	391430	44.0	33.9	22	22	36	69	395726	5	\$1,302.00
ST-180V	TAN	391479	62.0	34.1	22	22	47	92	395733	5	\$1,568.00
ST-200V	TAN	391503	81.0	33.2	22	22	56	103	633552	5	\$1,655.00
ST-210V	TAN	391607	86.0	46.4	26	26	47	123	395740	5	\$1,780.00

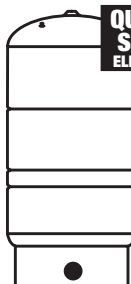

QUICK SHIP ELIGIBLE

T MODELS: THERM-X-SPAN® INLINE THERMAL EXPANSION TANKS, 1-Year Warranty

B

Model Number	Description	Part Number	Volume (Gal)	Max Acceptance Volume (Gal)	Shipping Dimensions (In)			Shipping Weight (Lbs)	UPC 642031	Standard Leadtime (Days)	List Price (USD)
					L	W	H				
 T-5	LIGHT PRIMER TAN	390517	2.0	0.9	8	8	13	5	548498	5 QS	\$69.80
T-12	LIGHT PRIMER TAN	390654	4.4	3.2	11	11	15	9	560889	5 QS	\$88.70



QUICK SHIP ELIGIBLE

Water Hammer Arrestors

WATER HAMMER ARRESTORS (SHOCK SUPPRESSORS)

K

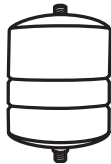
Model Number	Description	Part Number	Volume (Gal)	Shipping Dimensions (In)			Shipping Weight (Lbs)	UPC 642031	Standard Leadtime (Days)	List Price (USD)
				L	W	H				
 537-1	DIATROL® #537	394640	0.8	6	6	9	3	202932	10	\$226.00
541-1	DIATROL® #541	394645	1.0	6	6	12	5	203564	10	\$336.00

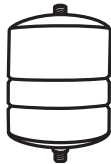

Pallet Quantity: ST-5 & T-5: 75, ST-12 & T-12: 48
 ST-25V, 30V & 42V: 18, ST-60V through ST-210V: 4

Connection: ST-1: 1/2" NPTM w/Stainless Steel Waterway; Stainless Steel: ST-5 through ST-12 & T-5 through T-12: 3/4" NPTM, ST-25V through ST-42V: 3/4" NPTF, ST-60V through ST-210V: 1-1/4" NPTF, Diatrol®: Stainless Steel NPTM; 537: 3/4"; 541: 1"

Warranty: ST-1 through ST-12: 7-Year Limited, ST-25V through ST-210V: 1-Year Limited, T-5 & T-12: 1-Year Limited, Diatrol®: 5-Year Limited

Maximum Operating Temp: ST-1: 140°F Intermittent; ST-5 through ST-210V: 200°F; Therm-X-Span and Diatrol: 200°F; Mini-Trol: 180°F Intermittent.
Maximum Working Pressure: 150 PSI

TUBE HANGERS: 601 SERIES

Model Number	Description	Part Number	Case Qty		Shipping Weight (Lbs)	UPC 642031	Standard Leadtime (Days)	List Price (USD)	
	601-1	1/2" DIAMETER	394656	10		1	208897	5	\$36.60
	601-2	3/4" DIAMETER	394657	10	Sold in full	1	208934	5	\$46.10
	601-3	1" DIAMETER	394658	10	case quantities	1	208941	5	\$52.60
	601-4	1-1/4" DIAMETER	394659	10	only	1	208958	5	\$62.40

NATICK STRAP HANGERS: 603 SERIES, 6" LENGTH

	603-1	1/2" DIAMETER	394670	25	Sold in full	2	209474	5	\$78.60
	603-3	3/4" DIAMETER	394672	25	case quantities	2	209641	5	\$79.40
	603-5	1" DIAMETER	394674	25	only	3	209726	5	\$79.90

NATICK STRAP HANGERS: 603 SERIES, 12" LENGTH

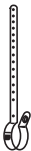
	603-2	1/2" DIAMETER	394671	25	Sold in full	3	209542	5	\$97.70
	603-4	3/4" DIAMETER	394673	25	case quantities	4	209719	5	\$98.30
	603-6	1" DIAMETER	394675	25	only	4	209825	5	\$99.30

GLIDE CLIPS: 604 SERIES

	604-1	1/2" DIAMETER	394678	10	Sold in full	1	210234	5	\$40.30
	604-2	3/4" DIAMETER	394679	10	case quantities	1	210241	5	\$43.40
	604-3	1" DIAMETER	394680	10	only	1	210258	5	\$54.10

VAN HANGERS: 606 SERIES

	606-2	1/2" DIAMETER	394682	20	Sold in full	2	210494	5	\$62.40
	606-3	3/4" DIAMETER	394683	20	case quantities	2	210500	5	\$66.90
	606-4	1" DIAMETER	394684	20	only	2	210517	5	\$73.40

TUBE STRAPS: 608 SERIES

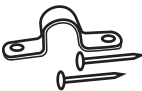
	608-4	1/2" DIAMETER	394685	100	Sold in full	2	210760	5	\$38.00
	608-6	3/4" DIAMETER	394686	50	case quantities	1	210777	5	\$25.50
	608-7	1" DIAMETER	394687	50	only	2	210784	5	\$27.10

Hardware: Strap Hangers, Glide Clips & Tube Straps include copper-clad nails.
 Tube Hangers & Van Hangers include copper-clad wood screws.

Warranty: 1-Year Limited

EX-PRO MODELS: EXTROL® PRO NEXT GENERATION HYDRONIC EXPANSION TANKS, 7-YEAR WARRANTY **B**

Model Number	Description	Part Number	Volume (Gal)	Max Acceptance Volume (Gal)	Shipping Dimensions (In)			Shipping Weight (Lbs)	UPC 642031	Standard Leadtime (Days)	List Price (USD)
					L	W	H				
EX-15PRO	MODEL #15 PRO	435339	2.0	1.0	8	8	13	5	353397	5	\$117.00
EX-30PRO	MODEL #30 PRO	435340	4.4	2.7	11	11	15	9	353403	5	\$145.00
EX-60PRO	MODEL #60 PRO	435341	6.7	2.7	11	11	20	13	353410	5	\$265.00



EX MODELS: EXTROL® INLINE BOILER SYSTEM EXPANSION TANKS, 7-YEAR WARRANTY **B**

EX-15	MODEL #15	389695	2.0	1.0	8	8	13	5	112743	5 QS	\$93.60
EX-30	MODEL #30	389710	4.4	2.5	11	11	15	9	113061	5 QS	\$116.00
EX-60	MODEL #60	389732	6.7	2.7	11	11	20	13	113221	5 QS	\$212.00
EX-90	MODEL #90	389802	14.0	11.3	15	15	21	23	115287	5 QS	\$352.00



SX MODELS: EXTROL VERTICAL BOILER SYSTEM EXPANSION TANKS, 1-YEAR WARRANTY **B**

SX-30V	STAND MODEL	390310	14	11.3	15	15	24	27	118967	5 QS	\$445.00
SX-40V	STAND MODEL	390317	20	11.3	15	15	32	35	119896	5	\$475.00
SX-60V	STAND MODEL	390321	32	11.3	15	15	48	46	119902	5 QS	\$666.00
SX-90V	STAND MODEL	390297	44	34.0	22	22	36	69	118714	5 QS	\$1,213.00
SX-110V	STAND MODEL	390298	62	34.0	22	22	47	92	118721	5	\$1,426.00
SX-130V	STAND MODEL	391502	81	34.0	22	22	56	103	633583	5	\$1,472.00
SX-160V	STAND MODEL	390299	86	46.0	26	26	47	123	118738	5	\$1,516.00

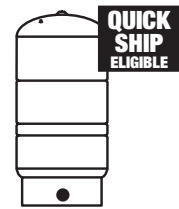

EX PACKAGES: EXTROL COMBINATION KITS, 7-YEAR WARRANTY **B**

EX-1500-100	EX-15 WITH 1" PURGER & VENT	389744	2.0	1.0	8	8	15	10	113382	5	\$165.00
EX-1500-125	EX-15 WITH 1-1/4" PURGER & VENT	389747	2.0	1.0	8	8	15	10	113412	5	\$165.00
EX-3000-100	EX-30 WITH 1" PURGER & VENT	389751	4.4	2.5	11	11	19	14	113504	5	\$185.00
EX-3000-125	EX-30 WITH 1-1/4" PURGER & VENT	389752	4.4	2.5	11	11	19	14	113528	5	\$185.00

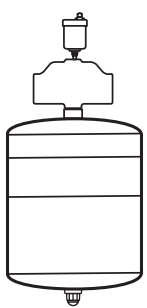

FT MODELS: FILL-TROL® TANKS AND AUTOMATIC FILL VALVES, 7-YEAR WARRANTY **B**

FT-109	FILL-TROL TANK & VALVE	389767	2.0	1.0	8	8	15	6	114198	5 QS	\$173.00
FT-110	FILL-TROL TANK & VALVE	389780	4.4	2.5	11	11	17	10	114525	5 QS	\$200.00
FT-111	FILL-TROL TANK & VALVE	389789	7.4	2.5	11	11	25	15	114914	5	\$306.00
FT-112	FILL-TROL TANK & VALVE	389803	14.0	11.3	15	15	23	24	115300	5	\$403.00
FT-15	FILL-TROL TANK ONLY	389769	2.0	1.0	8	8	13	5	114310	5	\$114.00
FT-30	FILL-TROL TANK ONLY	389778	4.4	2.5	11	11	15	9	114488	5	\$139.00
FT-109-15	FILL-TROL VALVE ONLY	389770	-	-	-	-	-	1	370143	5	\$87.70

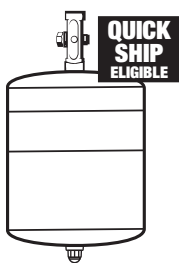

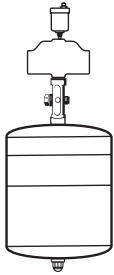
FT PACKAGES: FILL-TROL COMBINATION KITS, 7-YEAR WARRANTY
B

FT-109-100	FT-109 WITH 1" PURGER & VENT	389774	2.0	1.0	8	8	19	10	114433	5	\$236.00
FT-109-125	FT-109 WITH 1-1/4" PURGER & VENT	389768	2.0	1.0	8	8	19	10	114204	5	\$236.00
FT-110-100	FT-110 WITH 1" PURGER & VENT	389782	4.4	2.5	11	11	23	14	114600	5	\$262.00
FT-110-125	FT-110 WITH 1-1/4" PURGER & VENT	389781	4.4	2.5	11	11	23	14	114532	5	\$262.00
FT-111-125	FT-111 WITH 1-1/4" PURGER & VENT	389790	7.4	2.5	11	11	31	18	114938	5	\$365.00

 InSight
 EX-TROL PRO AND
 EX-TROL IN-LINE
 MODELS ONLY

Pallet Quantity: EX-15PRO: 75, EX-30PRO: 48, EX-60PRO: 32, Combination Packages: Same as base model

EX-15: 75, EX-30: 48, EX-60: 32, EX-90: 18, Combination Packages: Same as base model

Connection: SX-30V & SX-40V: 18, SX-60V: 9, SX-90V through SX-110V: 4, RX-15: 75, RX-30: 48, Stainless Steel: EX-15PRO through EX-60PRO; 1/2" NPTM, Steel: EX-15 through EX-90: 1/2" NPTM, SX-30V through SX-60V: 1" NPTF, SX-90V through SX-160V: 1-1/4" NPTF, Brass: FT Models: 1/2" NPTF

Warranty: EX-PRO, EX, FT Models: 7-Year Limited, SX Models: 1-Year Limited

Maximum Operating Temp: Extrol Pro: 200° F, Extrol, Fill-Trol: 240° F; Continuous 225° F

Maximum Working Pressure: EX-PRO: 125 PSI; Extrol, Fill-Trol: 100 PSI

Air Purgers, Vents & Valves
AIR VENTS
C

Model Number	Description	Part Number	Shipping Dimensions (In)			Shipping Weight (Lbs)	UPC 642031	Standard Leadtime (Days)	List Price (USD)
			L	W	H				
700-QC	FLOAT VENT, 1/8" QUICK-CHANGE	394697	2	2	4	0.5	591982	5	\$22.50
701-C	FLOAT VENT, 1/4" CONNECTION	394698	2	2	4	0.5	389473	5	\$22.50
700-C	FLOAT VENT, 1/8" CONNECTION	394695	2	2	4	0.5	389466	5	\$20.20

AIR PURGERS
C

443-1	CAST AIR PURGER 1"	393989	6	3	4	4	193117	5	\$44.70
444-1	CAST AIR PURGER 1-1/4"	399678	6	3	4	4	193148	5	\$44.70
445-1	CAST AIR PURGER 1-1/2"	393993	8	4	5	9	193186	5	\$101.00
446-1	CAST AIR PURGER 2"	393994	8	4	5	10	193223	5	\$111.00
447-1	CAST AIR PURGER 2-1/2"	393995	10	5	6	19	193254	5	\$266.00
448-1	CAST AIR PURGER 3"	393996	10	5	6	20	193261	5	\$320.00

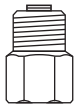
TANK SERVICE CHECK VALVE
C

140-470	SERVICE CHECK, 1/2" QUICK CHANGE	399673	1	1	1	0.1	603487	5	\$21.60
---------	----------------------------------	--------	---	---	---	-----	--------	---	---------

MIXING VALVES
C

420-1	1/2" DOMESTIC WATER 110-170F	393986	2	2	4	1	190819	5	\$175.00
421-1	3/4" DOMESTIC WATER 110-170F	393988	2	2	4	1	190888	5	\$192.00
420-6	REPLACEMENT CARTRIDGE	393987	-	-	-	1	190826	5	\$58.20

Case Qty: Air Vents: 24, 443 & 444 Purgers:12

Purger Vent Tpng: 443 through 445: 1/8" NPT, 446: 1/2" NPT, 447 & 448: 3/4" NPT

Purger Exp Tpng: 443 through 448: 1/2" NPT

Warranty: 1-Year Limited

HYDROMAX® INDIRECT-FIRED WATER HEATERS

G

QUICK SHIP ELIGIBLE
HM MODELS

Model Number	Part Number	Coil	Control	Color	Volume (Gal)	Shipping Dimensions (In)			Shipping Weight (Lbs)	UPC 642031	Standard Leadtime (Days)	List Price (USD)
						L	W	H				
HM-41Z	399265	140MBH TOP	MECHANICAL	BLACK	41	22	22	55	124	653000	5 QS	\$2,635.00
HM-41ZDW	399267	140MBH TOP	MECHANICAL DBL WALL	BLACK	41	22	22	55	134	659842	5	\$3,545.00
HM-41L	399264	140MBH TOP	ENER-G-NET™	BLACK	41	22	22	55	124	654168	5	\$2,817.00
HM-41LDW	399266	140MBH TOP	ENER-G-NET DBL WALL	BLACK	41	22	22	55	134	659859	5	\$3,725.00
HM-80Z	399263	140MBH TOP	MECHANICAL	BLACK	80	26	26	62	180	654007	5	\$3,562.00
HM-80ZDW	399269	140MBH TOP	MECHANICAL DBL WALL	BLACK	80	26	26	62	190	659835	5	\$4,469.00
HM-80L	399262	140MBH TOP	ENER-G-NET	BLACK	80	26	26	62	180	654199	5	\$3,746.00
HM-80LDW	399268	140MBH TOP	ENER-G-NET DBL WALL	BLACK	80	26	26	62	190	659828	5	\$4,655.00

BOILERMATE® INDIRECT-FIRED WATER HEATERS

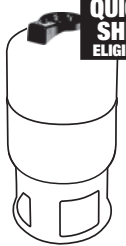
G

QUICK SHIP ELIGIBLE
CH MODELS

CH-41Z-B	399087	100MBH TOP	MECHANICAL	BLUE	41	22	22	48	124	632951	10 QS	\$2,389.00
CH-41Z-R	399082	100MBH TOP	MECHANICAL	RED	41	22	22	48	124	632937	10	\$2,389.00
CH-41Z-G	399085	100MBH TOP	MECHANICAL	GRAY	41	22	22	48	124	630773	10	\$2,389.00
CH-41ZDW-B	399081	100MBH TOP DBL WALL	MECHANICAL	BLUE	41	22	22	48	134	646040	10	\$2,998.00
CH-41ZDW-R	407732	100MBH TOP DBL WALL	MECHANICAL	RED	41	22	22	48	134	646033	10	\$2,998.00
CH-41ZDW-G	399080	100MBH TOP DBL WALL	MECHANICAL	GRAY	41	22	22	48	134	646026	10	\$2,998.00
CH-41ZCT-B	399092	100MBH TOP	CONSTANT TEMP	BLUE	41	22	22	51	127	637376	15	\$3,084.00
CH-41ZCT-R	399090	100MBH TOP	CONSTANT TEMP	RED	41	22	22	51	127	638243	15	\$3,084.00
CH-41ZCT-G	399091	100MBH TOP	CONSTANT TEMP	GRAY	41	22	22	51	127	638236	15	\$3,084.00
CH-80Z-B	399078	100MBH TOP	MECHANICAL	BLUE	80	26	26	49	180	636324	10	\$3,407.00
CH-80Z-R	399076	100MBH TOP	MECHANICAL	RED	80	26	26	49	180	636300	10	\$3,407.00
CH-80Z-G	399077	100MBH TOP	MECHANICAL	GRAY	80	26	26	49	180	635969	10	\$3,407.00
CH-80ZDW-B	399075	100MBH TOP DBL WALL	MECHANICAL	BLUE	80	26	26	49	190	646071	10	\$4,267.00
CH-80ZDW-R	399073	100MBH TOP DBL WALL	MECHANICAL	RED	80	26	26	49	190	646057	10	\$4,267.00
CH-80ZDW-G	399074	100MBH TOP DBL WALL	MECHANICAL	GRAY	80	26	26	49	190	646064	10	\$4,267.00

HOT WATER MAKER REPLACEMENT PARTS

I
CONTROLS

2704-093	393232	AQUASTAT: RESIDENTIAL 150F, ALL EXC WH-10	MECHANICAL	390028	1	\$207.00
2775-454	393513	AQUASTAT: COMMERCIAL 180F, ALL EXC WH-10	MECHANICAL	519658	1	\$278.00
2770-133	399930	AQUASTAT: 150F, WH-10	MECHANICAL	343475	1	\$207.00
940R101	396411	DIGITAL CONTROL REPLACEMENT & UPGRADE, WH, TD & WHS	DIGITAL	654144	1	\$500.00
940R2	396413	ENER-G-NET DIGITAL CONTROL ONLY	DIGITAL	654069	1	\$492.00
2704-259	393281	DIGITAL TEMPERATURE SENSOR ONLY (THERMISTOR)	DIGITAL	432650	1	\$64.30
2704-392	393290	AQUASTAT RETROFIT KIT, WH	MECHANICAL	466846	1	\$414.00
2704-487	393314	AQUASTAT RETROFIT KIT W/RELAY, WH	MECHANICAL	611888	1	\$474.00
2775-455	393514	AQUASTAT RETROFIT KIT, WHS	MECHANICAL	519726	1	\$414.00
2775-768	393557	AQUASTAT RETROFIT KIT W/RELAY, WHS	MECHANICAL	611857	1	\$474.00
2704-529	393332	UNIVERSAL 10K DIGITAL TEMP SENSOR KIT	DIGITAL	651044	1	\$67.40

HEAT EXCHANGER COILS

2700-5001	393038	WH-7C & WHS-C COMMERCIAL MODELS	534101	1	\$2,175.00
2700-5002	393039	WH-DW DBL-WALL MODELS (EXCEPT WH-7C)	534118	1	\$3,018.00
2700-5003	393040	WH-7CDW & WHS-CDW COM. DBL. WALL MDLS	534125	1	\$3,847.00
2703R003	393200	CH-41 MODELS	641762	1	\$1,272.00
2702R002	393169	CH-80 MODELS	659934	1	\$1,331.00
2701R007	N / A	CH-80 DW DOUBLE-WALL MODELS	686954	1	\$2,551.00
2775-82	431262	WHS MODELS (EXCEPT C & DW)	312622	1	\$1,836.00
2775-83	393571	WHS-DW RESIDENTIAL MODELS	534385	1	\$3,055.00
2775-84	393572	WHS-DW COMMERCIAL MODELS	534392	1	\$3,977.00
2713R002	393465	HM-41 MODELS	659958	1	\$1,623.00
2712R002	393448	HM-80 MODELS	659941	1	\$1,695.00
2801R002	N / A	HM-80 DW DOUBLE-WALL MODELS	686947	1	\$2,910.00
426113	426113	Coil Replacement Kit DC-CW	261135	1	\$4,091.00

MISC PARTS

2700-924	393070	AQUASTAT DRY WELL	166357	1	\$98.70
2500-218	392923	HEAT EXCHANGER COIL GASKET, 8 BOLT	160768	1	\$12.80
2500-178	392922	WH TOP OUTLET O-RING	160690	1	\$1.70
2700-635	393053	WH TOP OUTLET UNION TEE PACKAGE	164438	1	\$132.00
2703R001	393199	DIP TUBE, CH-41	673503	1	\$19.50
2702R001	393168	DIP TUBE, CH-80	677389	1	\$24.30
9340R160	N / A	DRAIN VALVE ASSEMBLY, ALL CH & HM	671271	1	\$121.00
2700R1106	393107	T&P RELIEF VALVE, RESIDENTIAL	643896	1	\$58.00
2704R512	393381	TOP COVER HALF, HM-41 & HM-80	677372	1	\$62.60
2783R512	N / A	HEAT TRAP, ALL HM	677365	1	\$39.50
2783R004	N / A	T&P BLOWDOWN TUBE: HM-41	677341	1	\$70.30
2782R002	N / A	T&P BLOWDOWN TUBE: HM-80	677358	1	\$70.50

PREMIER™ INDIRECT-FIRED WATER HEATERS

G

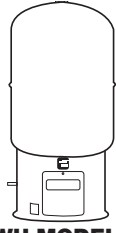
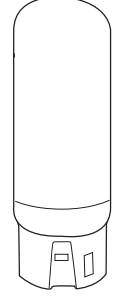
Model Number	Part Number	Coil	Control	Material	Volume (Gal)	Shipping Dimensions (In)			Shipping Weight (Lbs)	UPC 642031	Standard Leadtime (Days)	List Price (USD)	
						L	W	H					
 WH MODELS	WH-7C	398874	240MBH BOTTOM	DIGITAL	180F Poly	41	22	22	48	144	557414	10	\$4,745
	WH-7ZC	399164	240MBH BOTTOM	MECHANICAL	180F Poly	41	22	22	48	144	582072	10	\$4,545
	WH-7CDW	398873	240MBH BOTTOM DBL WALL	DIGITAL	180F Poly	41	22	22	48	154	557407	10	\$5,734
 WHS & DC MODELS	WHS-60Z	399220	140MBH BOTTOM	MECHANICAL	Stainless	60	26	26	54	160	557506	10	\$4,491
	WHS-60L	399218	140MBH BOTTOM	DIGITAL	Stainless	60	26	26	54	160	557483	10	\$4,707
	WHS-60ZDW	399221	140MBH BOTTOM DBL WALL	MECHANICAL	Stainless	60	26	26	54	170	557513	10	\$4,924
	WHS-60LDW	399219	140MBH BOTTOM DBL WALL	DIGITAL	Stainless	60	26	26	54	170	557490	10	\$5,141
	WHS-60ZC	399234	240MBH BOTTOM	MECHANICAL	Stainless	60	26	26	54	170	575753	10	\$4,996
	WHS-60ZCDW	399222	240MBH BOTTOM DBL WALL	MECHANICAL	Stainless	60	26	26	54	170	557520	10	\$5,649
	WHS-80Z	399225	140MBH BOTTOM	MECHANICAL	Stainless	80	26	26	66	170	557551	10	\$4,987
	WHS-80L	399223	140MBH BOTTOM	DIGITAL	Stainless	80	26	26	66	170	557537	10	\$4,996
	WHS-80ZDW	399226	140MBH BOTTOM DBL WALL	MECHANICAL	Stainless	80	26	26	66	180	557568	10	\$5,214
	WHS-80LDW	399224	140MBH BOTTOM DBL WALL	DIGITAL	Stainless	80	26	26	66	180	557544	10	\$5,431
	WHS-80ZC	399233	240MBH BOTTOM	MECHANICAL	Stainless	80	26	26	66	180	575777	10	\$5,286
	WHS-80ZCDW	399227	240MBH BOTTOM DBL WALL	MECHANICAL	Stainless	80	26	26	66	180	557575	10	\$5,939
DC-80DW	399236	DUAL DBL WALL EXCHANGERS	MECHANICAL	Stainless	80	26	26	66	200	584182	10	\$7,023	
WHS-120Z	399230	140MBH BOTTOM	MECHANICAL	Stainless	120	30	30	71	200	557605	10	\$6,518	
WHS-120L	399228	140MBH BOTTOM	DIGITAL	Stainless	120	30	30	71	200	557599	10	\$6,735	
WHS-120ZC	399232	240MBH BOTTOM	MECHANICAL	Stainless	120	30	30	71	200	575791	10	\$7,023	
WHS-120ZCDW	399231	240MBH BOTTOM DBL WALL	MECHANICAL	Stainless	120	30	30	71	210	557612	10	\$7,676	
DC-120DW	399238	DUAL DBL WALL EXCHANGERS	MECHANICAL	Stainless	120	30	30	71	230	584243	10	\$8,762	

PREMIER HOT WATER STORAGE TANKS

G

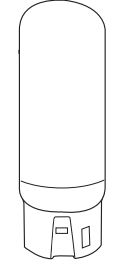
Model Number	Part Number	Volume (Gal)	Shipping Dimensions (In)			Shipping Weight (Lbs)	UPC 642031	Standard Leadtime (Days)	List Price (USD)	
			L	W	H					
 S MODELS	S-80	399195	80	26	26	66	156	552426	10	\$3,476.00
	S-120	393520	120	30	30	71	196	552433	10	\$5,214.00



Pallet Quantity: All Models: 4
Warranty: HM Models: 7-Years with Limited Lifetime upgrade option in carton
 CH & WH Models: 6-Years with Limited Lifetime upgrade option in carton
 WHS, DC & S Models: 10-Year Limited (Residential), 5-Year Limited (Commercial)
Hardware: All models include T&P relief and drain valves

APPLICATIONS & ORDERING

- For use in non-potable closed hydronic and chilled water systems.
- Fixed diaphragm construction.
- Available in Horizontal and Vertical configurations.
- Deep Drawn models are lighter, stronger and more compact than traditional head and shell construction.
- Constructed to ASME Section VIII, Division 1.
- Maximum Operating Temperature: 240° F.

How to Order: Specify Model & Options

AX-80-125SGR

- Step 1: Select Base Model Number
 Step 2: Choose Pressure Rating
 Step 3: Specify Sight Glass Option (or leave blank)
 Step 4: Specify Restraint Option (or leave blank)

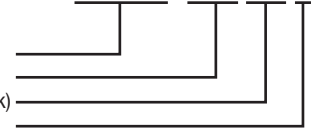

AX-80 (Horizontal) 125 PSI Rating with Sight Glass & Restraints

AX MODELS: DEEP DRAWN DIAPHRAGM TYPE, ASME

J

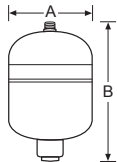

AX-10DD

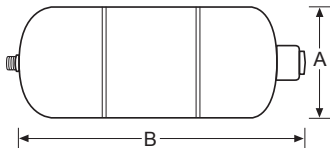

AX-15DD THROUGH AX-40-DD

TECHNICAL DATA

Base Model Number	Volume (Gal)	Max Acceptance Volume (Gal)	A Diameter (In)	B Length (In)	Shipping Weight (Lbs)				
					125 PSI	150 PSI	175 PSI	250 PSI	300 PSI
AX-10-DD	6.4	3.2	12	18	9	10	NA	NA	NA
AX-15-DD	8.6	3.2	12	22	22	24	NA	NA	NA
AX-20-DD	16.5	11.3	15	25	44	46	NA	NA	NA
AX-40-DD	23.0	11.3	15	33	64	66	NA	NA	NA

PRICING: DEEP DRAWN DIAPHRAGM TYPE, ASME MODELS

Base Model Number	Part No. / List Price (USD)				
	125 PSI	150 PSI	175 PSI	250 PSI	300 PSI
AX-10-DD	416836 / \$2,195	401797 / \$2,414	NA	NA	NA
AX-15-DD	416837 / \$2,299	401798 / \$2,529	NA	NA	NA
AX-20-DD	416839 / \$2,337	401803 / \$2,568	NA	NA	NA
AX-40-DD	416841 / \$3,284	416070 / \$3,609	NA	NA	NA

AX MODELS: HEAD & SHELL DIAPHRAGM TYPE, ASME

J

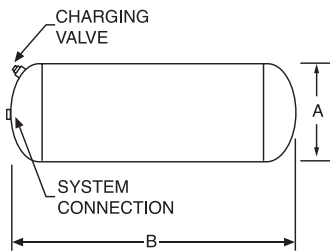

AX-15 THROUGH AX-240

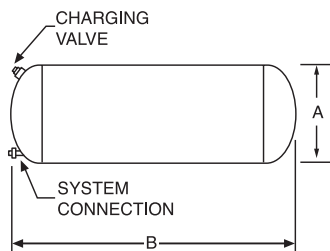

AX-260 & AX-280

TECHNICAL DATA

Base Model Number	Volume (Gal)	Max Acceptance Volume (Gal)	A-Diameter (In)	B-Length (In)	Shipping Weight (Lbs)				
					125 PSI	150 PSI	175 PSI	250 PSI	300 PSI
AX-15	8.0	2.4	12	19	NA	NA	48	55	59
AX-20	10.9	2.4	12	26	NA	NA	60	69	74
AX-40	21.7	11.3	16	29	NA	NA	96	111	118
AX-60	33.6	11.3	16	43	96	120	125	144	154
AX-80	44.4	22.6	24	29	153	160	200	230	245
AX-100	55.7	22.6	24	33	174	180	227	261	279
AX-120	68.0	34.0	24	41	204	245	266	306	327
AX-144	77.0	34.0	24	46	218	250	285	327	350
AX-180	90.0	34.0	24	54	232	265	301	348	372
AX-200	110.0	34.0	24	64	269	320	350	404	430
AX-240	132.0	46.0	30	51	401	403	522	602	642
AX-260	159.0	56.0	30	62	455	460	572	683	728
AX-280	211.0	84.0	30	80	580	600	755	870	930

PRICING: HEAD & SHELL DIAPHRAGM TYPE, ASME MODELS

Base Model Number	Part No. / List Price (USD)				
	125 PSI	150 PSI	175 PSI	250 PSI	300 PSI
AX-15	NA	NA	411429 / \$2,660	390134 / \$2,926	\$3,222
AX-20	NA	NA	424867 / \$2,704	\$2,974	\$3,274
AX-40	NA	NA	409432 / \$3,802	435803 / \$4,183	\$4,599
AX-60	427434 / \$3,451	390010 / \$3,797	117-554 / \$4,178	\$4,595	\$5,058
AX-80	390178 / \$4,379	410087 / \$4,820	\$5,300	\$5,831	\$6,414
AX-100	389895 / \$4,530	416216 / \$4,982	\$5,481	\$6,031	\$6,629
AX-120	389926 / \$4,782	390020 / \$5,261	117-553 / \$5,642	\$6,363	\$6,970
AX-144	389932 / \$5,223	\$5,744	\$6,322	\$6,958	\$7,641
AX-180	389938 / \$5,517	390024 / \$6,067	\$6,667	\$7,337	\$8,083
AX-200	389944 / \$5,893	390027 / \$6,477	389995 / \$7,135	\$7,843	\$8,615
AX-240	389967 / \$6,742	390030 / \$7,413	\$8,159	\$8,994	\$9,880
AX-260	389974 / \$9,235	425212 / \$10,145	\$11,157	\$12,283	\$13,504
AX-280	389978 / \$11,208	426387 / \$12,321	390147 / \$12,625	\$14,896	\$16,414

Additional Options: Add to Base Model List Price
Sight Glass (SG): \$482
Restraints (Saddles) (R): AX-15 & 20: \$214, AX-40 & 60: \$328, AX-80 through 200: \$495, AX-240 through 280: \$659

Standard Leadtime: AX-10-DD and AX-15-DD 125 PSI: Up to 5 units - 5 Days; Over 5 units - 10 Days
 All other models 125 & 150 PSI: 10 Days, 175 PSI: 30 Days, 250 & 300 PSI: 40 Days
Connection: Malleable Iron: AX-15 through AX-60: 1/2", AX-10-DD through AX-40-DD: 3/4", AX-80 through AX-240: 1", AX-260 & AX-280: 1-1/4", AX-10-DD through AX-40-DD: NPTM, Center, AX-15 through AX-100: NPTF, Center, AX-120 through AX-240: NPTM, Center, AX-260 & AX-280: NPTM, Offset
Factory Precharge: All models: 12 PSI
Warranty: 1-Year Limited

APPLICATIONS & ORDERING

- For use in non-potable closed hydronic and chilled water systems.
- Fixed diaphragm construction.
- Available in Horizontal and Vertical configurations.
- Deep Drawn models are lighter, stronger and more compact than traditional head and shell construction.
- Constructed to ASME Section VIII, Division 1.
- Maximum Operating Temperature: 240° F.

How to Order: Specify Model & Options

AX-120V-150

- Step 1: Select Base Model Number
- Step 2: Choose Pressure Rating
- Step 3: Specify Sight Glass Option (or leave blank)
- Step 4: Specify Restraint Option (or leave blank)

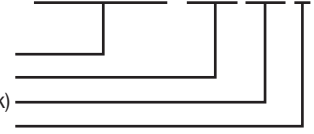

AX-120V (Vertical) 150 PSI Rating (No Sight Glass and Restraints)

AX-V MODELS: DEEP DRAWN DIAPHRAGM TYPE, ASME

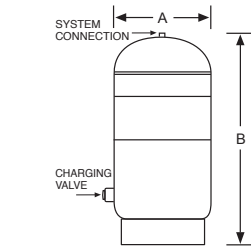

AX-15V-DD THROUGH AX-40V-DD

TECHNICAL DATA

Base Model Number	Volume (Gal)	Max Acceptance Volume (Gal)	A-Diameter (In)	B-Height (In)	Shipping Weight (Lbs)				
					125 PSI	150 PSI	175 PSI	250 PSI	300 PSI
AX-15V-DD	8.6	3.2	12	22	24	26	NA	NA	NA
AX-20V-DD	16.5	11.3	15	25	46	48	NA	NA	NA
AX-40V-DD	23.0	11.3	15	33	66	68	NA	NA	NA

PRICING: DEEP DRAWN DIAPHRAGM TYPE, ASME MODELS

Base Model Number	Part No. / List Price (USD)				
	125 PSI	150 PSI	175 PSI	250 PSI	300 PSI
AX-15V-DD	416838 / \$2,300	401799 / \$2,530	NA	NA	NA
AX-20V-DD	416840 / \$2,337	415253 / \$2,568	NA	NA	NA
AX-40V-DD	416842 / \$3,284	401804 / \$3,609	NA	NA	NA

AX-V MODELS: HEAD & SHELL DIAPHRAGM TYPE, ASME

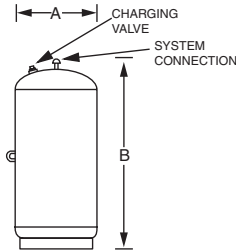

AX-15V THROUGH AX-100V

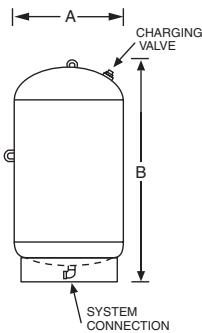

AX-120V THROUGH AX-240V

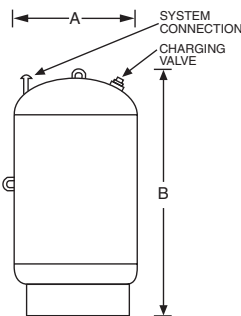

AX-260V & AX-280V

TECHNICAL DATA

Base Model Number	Volume (Gal)	Max Acceptance Volume (Gal)	A-Diameter (In)	B-Height (In)	Shipping Weight (Lbs)				
					125 PSI	150 PSI	175 PSI	250 PSI	300 PSI
AX-15V	8.0	2.4	12	20	NA	NA	49	59	62
AX-20V	10.9	2.4	12	27	NA	NA	61	71	75
AX-40V	21.7	11.3	16	30	NA	NA	99	114	122
AX-60V	33.6	11.3	16	45	98	103	127	147	157
AX-80V	44.4	22.6	24	29	155	167	201	233	248
AX-100V	55.7	22.6	24	34	176	187	229	264	282
AX-120V	68.0	34.0	24	47	214	255	278	321	342
AX-144V	77.0	34.0	24	52	230	267	299	345	368
AX-180V	90.0	34.0	24	60	271	275	352	407	434
AX-200V	110.0	34.0	24	66	290	358	377	435	464
AX-240V	132.0	46.0	30	58	401	403	521	602	642
AX-260V	159.0	56.0	30	65	460	467	598	690	736
AX-280V	211.0	84.0	30	82	590	605	767	885	945

PRICING: HEAD & SHELL DIAPHRAGM TYPE, ASME MODELS

Base Model Number	Part No. / List Price (USD)				
	125 PSI	150 PSI	175 PSI	250 PSI	300 PSI
AX-15V	NA	NA	389999 / \$2,661	390081 / \$2,927	390107 / \$3,223
AX-20V	NA	NA	389997 / \$2,704	390097 / \$2,974	\$3,274
AX-40V	NA	NA	389998 / \$3,802	390146 / \$4,183	390137 / \$4,599
AX-60V	427436 / \$3,451	390012 / \$3,797	389869 / \$4,178	390112 / \$4,595	\$5,058
AX-80V	435434 / \$4,405	390016 / \$4,845	390109 / \$5,329	413401 / \$5,862	\$6,452
AX-100V	389900 / \$4,540	390019 / \$4,992	421614 / \$5,492	424957 / \$6,042	390080 / \$6,654
AX-120V	389927 / \$5,454	390021 / \$6,004	390133 / \$6,603	\$7,248	\$8,007
AX-144V	389933 / \$5,813	390023 / \$6,401	\$7,033	389905 / \$7,754	390110 / \$8,526
AX-180V	389939 / \$6,603	390026 / \$7,248	390091 / \$8,007	\$8,779	\$9,665
AX-200V	389945 / \$6,755	390029 / \$7,438	400764 / \$8,172	\$9,007	\$9,892
AX-240V	389955 / \$7,780	390031 / \$8,539	426297 / \$9,386	\$10,322	409488 / \$11,372
AX-260V	389975 / \$9,386	390034 / \$10,322	424338 / \$11,385	417542 / \$12,511	\$13,757
AX-280V	389979 / \$11,587	390037 / \$12,745	390101 / \$14,010	420524 / \$15,402	\$16,951

- Additional Options:** Add to Base Model List Price
Sight Glass (SG): \$482
Seismic Restraints (R): \$339

- Standard Leadtime:** AX-15V-DD 125 PSI: Up to 5 units - 5 Days; Over 5 units - 10 Days
 All other models 125 & 150 PSI: 10 Days, 175 PSI: 30 Days, 250 & 300 PSI: 40 Days
 Malleable Iron: AX-15V through AX-60V: 1/2", AX-15V-DD through AX-40V-DD: 3/4"
 AX-80V through AX-240V: 1", AX-260V & AX-280V: 1-1/4"
 AX-15V-DD through AX-40V-DD: NPTM, Center, AX-15V through AX-100V: NPTF, Center
 AX-120V through AX-240V: NPTF, Bottom, AX-260V & AX-280V: NPTM, Offset

- Factory Precharge:** All models: 12 PSI
Warranty: 1-Year Limited

APPLICATIONS & ORDERING

- For use in non-potable closed hydronic and chilled water systems.
- Replaceable bladder construction.
- Available in Full Acceptance versions.
- Constructed to ASME Section VIII, Division 1.
- Maximum Operating Temperature: 240° F.

How to Order: Specify Model & Options

800-L-175SGR

- Step 1: Select Base Model Number
 Step 2: Choose Pressure Rating
 Step 3: Specify Sight Glass Option (or leave blank)
 Step 4: Specify Restraint Option (or leave blank)

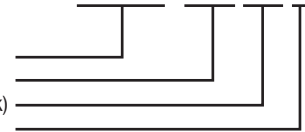

800-L 175 PSI Rating with Sight Glass & Restraints

L MODELS: FULL ACCEPTANCE BLADDER, TOP CONNECTION, ASME

J

TECHNICAL DATA

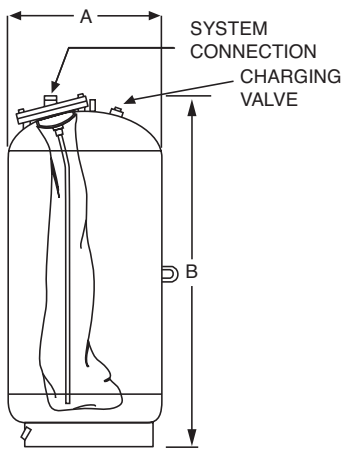

Base Model Number	Volume (Gal)	Max Acceptance Volume (Gal)	A Diameter (In)	B Height (In)	Shipping Weight (Lbs)				
					125 PSI	150 PSI	175 PSI	250 PSI	300 PSI
200-L	53	53	24	38	190	205	250	290	297
300-L	80	80	24	52	230	292	320	385	372
400-L	106	106	24	66	275	343	375	465	595
500-L	132	132	24	79	311	372	435	545	750
600-L	158	158	30	64	439	510	595	720	810
800-L	211	211	30	82	543	565	620	905	950
1000-L	264	264	36	74	609	750	750	1,015	1,065
1200-L	317	317	36	86	700	860	860	1,175	1,235
1400-L	370	370	36	98	783	970	970	1,335	1,400
1600-L	422	422	48	69	1,106	1,425	1,615	1,916	2,015
2000-L	528	528	48	84	1,284	1,675	2,386	2,410	2,651
2500-L	660	660	48	101	1,544	1,945	2,411	2,585	2,715
3000-L	792	792	48	118	1,719	2,225	2,500	2,950	3,100
3500-L	925	925	54	111	2,187	2,375	2,620	3,660	3,780
4000-L	1,057	1,057	54	125	2,352	2,640	3,000	4,080	4,285
5000-L	1,321	1,321	60	128	2,450	3,740	4,100	4,200	5,200
7500-L	1,980	1,980	72	127	4,000	4,300	4,500	5,550	6,750
10000-L	2,640	2,640	72	159	4,900	5,300	5,500	6,800	11,000
15000-L	3,963	3,963	72	233	6,000	7,600	7,900	9,800	12,500

200-L THROUGH 15000-L

PRICING: ASME MODELS

Base Model Number	Part No. / List Price (USD)				
	125 PSI	150 PSI	175 PSI	250 PSI	300 PSI
200-L	392691 / \$7,147	390045 / \$8,298	392690 / \$9,450	392689 / \$10,879	191-42 / \$12,498
300-L	392746 / \$7,641	390046 / \$8,804	392747 / \$10,120	409501 / \$11,625	392759 / \$13,378
400-L	392772 / \$8,134	390047 / \$9,348	392773 / \$10,765	408366 / \$12,372	438314 / \$14,231
500-L	392800 / \$8,539	390048 / \$9,804	392799 / \$11,284	408367 / \$12,966	194-37 / \$14,927
600-L	391797 / \$12,030	390049 / \$13,852	414110 / \$15,939	425741 / \$18,343	194-39 / \$21,062
800-L	391828 / \$13,062	390050 / \$15,022	391829 / \$17,331	391830 / \$19,893	391834 / \$22,897
1000-L	391854 / \$15,022	390051 / \$17,363	391855 / \$19,956	176-23 / \$22,929	415236 / \$26,344
1200-L	391874 / \$16,066	390052 / \$18,438	177-22 / \$21,252	391873 / \$24,415	177-33 / \$28,083
1400-L	391888 / \$17,173	390053 / \$19,734	391889 / \$22,707	391890 / \$26,091	426905 / \$30,013
1600-L	391913 / \$24,700	390054 / \$28,463	179-22 / \$32,700	391915 / \$37,571	179-34 / \$43,263
2000-L	391969 / \$26,818	390055 / \$30,803	391970 / \$35,389	435802 / \$40,733	392004 / \$46,868
2500-L	391976 / \$30,898	390056 / \$35,673	426901 / \$40,923	391985 / \$47,058	435329 / \$54,079
3000-L	391977 / \$39,310	390057 / \$45,097	180-39 / \$51,928	391986 / \$59,708	418904 / \$68,626
3500-L	392643 / \$47,659	390058 / \$54,807	/ \$63,029	391987 / \$72,485	180-78 / \$83,490
4000-L	392646 / \$55,439	400946 / \$65,337	426900 / \$73,244	180-46 / \$84,376	418905 / \$97,026
5000-L	392651 / \$73,180	117-940 / \$84,249	391997 / \$96,709	189-7 / \$111,257	180-129 / \$128,018
7500-L	392649 / \$129,157	390015 / \$148,638	433361 / \$170,649	392660 / \$196,455	392007 / \$225,929
10000-L	392665 / \$148,132	117-941 / \$170,143	180-57 / \$195,822	180-58 / \$225,170	392008 / \$258,819
15000-L	392644 / \$196,708	117-475 / \$226,056	391995 / \$260,084	180-60 / \$299,046	180-83 / \$343,827

Additional Options: Add to Base Model List Price
Sight Glass (SG): \$482
Seismic Restraints (R): \$339

Standard Leadtime: 200-L through 4000-L: 125 & 150 PSI: 10 Days, 175 PSI: 30 Days, 250 & 300 PSI: 40 Days
 5000-L: 125,150 & 175 PSI: 30 Days, 250 & 300 PSI: 60 Days,
 7500-L through 15000-L: All pressures: 60 Days

Connection (NPTF): Malleable Iron: 200-L through 500-L: 1", 600-L through 2000-L: 1-1/2", 2500-L through 5000-L: 2", 7500-L through 15000-L: 3"

Factory Precharge: All models: 12 PSI
Warranty: 1-Year Limited

APPLICATIONS & ORDERING

- For use in non-potable closed hydronic and chilled water systems.
- Replaceable bladder construction.
- Available in Partial Acceptance versions.
- Constructed to ASME Section VIII, Division 1.
- Maximum Operating Temperature: 240° F.

How to Order: Specify Model & Options

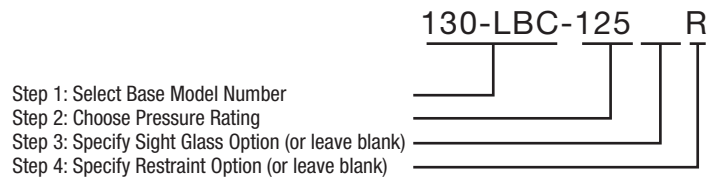

130-LBC 125 PSI Rating with Restraints (No Sight Glass)

LBC MODELS: PARTIAL ACCEPTANCE BLADDER, BOTTOM CONNECTION, ASME

J

TECHNICAL DATA

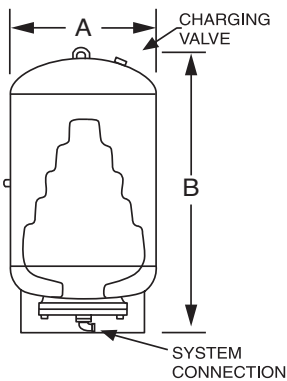

Base Model Number	Volume (Gal)	Max Acceptance Volume (Gal)	A Diameter (In)	B Height (In)	Shipping Weight (Lbs)				
					125 PSI	150 PSI	175 PSI	250 PSI	300 PSI
35-LBC	10	10	10	37	67	76	80	94	100
50-LBC	13	11	12	37	76	78	91	106	114
85-LBC	22	11	16	35	92	95	110	129	138
100-LBC	26	11	16	39	99	102	119	138	150
130-LBC	34	27	20	35	135	140	162	189	202
165-LBC	44	27	20	40	149	153	178	214	225
200-LBC	53	27	24	41	195	205	234	273	293
300-LBC	80	27	24	56	233	254	280	326	350
400-LBC	106	53	24	69	274	308	329	383	411
500-LBC	132	53	24	83	310	352	372	434	465
600-LBC	158	53	30	67	438	442	525	613	657

PRICING: ASME MODELS

Base Model Number	Part No. / List Price (USD)				
	125 PSI	150 PSI	175 PSI	250 PSI	300 PSI
35-LBC	391655 / \$5,099	391645 / \$5,862	420170 / \$6,742	\$7,780	\$8,906
50-LBC	391685 / \$5,155	391675 / \$5,925	\$6,667	391682 / \$7,843	\$9,019
85-LBC	391715 / \$5,226	391705 / \$6,010	\$6,907	429346 / \$7,957	\$9,159
100-LBC	391732 / \$5,304	391728 / \$6,100	415770 / \$7,008	\$8,071	\$9,285
130-LBC	391746 / \$5,376	390038 / \$6,182	438017 / \$7,109	\$8,172	\$9,399
165-LBC	391760 / \$5,510	390039 / \$6,338	390120 / \$7,299	\$8,374	\$9,639
200-LBC	392697 / \$5,599	390040 / \$6,439	\$7,400	\$8,526	\$9,791
300-LBC	392752 / \$5,779	401106 / \$6,654	\$7,641	\$8,804	\$10,120
400-LBC	392778 / \$6,806	390042 / \$7,830	117-03 / \$9,019	\$10,348	\$11,904
500-LBC	392804 / \$7,337	390043 / \$8,425	\$9,715	422705 / \$11,157	\$12,840
600-LBC	391802 / \$9,159	390044 / \$10,537	\$12,119	\$13,947	\$16,066

Additional Options: Add to Base Model List Price
Sight Glass (SG): \$482
Seismic Restraints (R): \$339

Standard Leadtime: 125 & 150 PSI: 10 Days, 175 PSI: 30 Days, 250 & 300 PSI: 40 Days
Connection (NPTF): Malleable Iron: All LBC Models: 1"
Factory Precharge: All models: 12 PSI
Warranty: 1-Year Limited

35-LBC THROUGH 600-LBC

APPLICATIONS & ORDERING

- For use in non-potable closed hydronic and chilled water systems.
- Constructed to ASME Section VIII, Division 1.

How to Order: Specify Model & Options

6-ASL-125

Step 1: Select Base Model Number
Step 2: Choose Pressure Rating

6-Inch Air Separator Less Strainer, 125 PSI Rating

TANGENTIAL AIR SEPARATORS, LESS STRAINER, ASME

J

TECHNICAL DATA

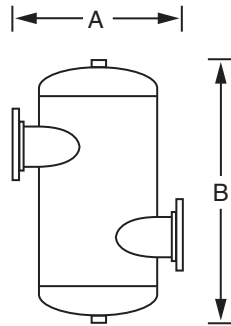

1-ASL THROUGH 4-ASL

Base Model Number	Connection Size (In)	A Width (In)	B Height (In)	Shipping Weight (Lbs)				
				125 PSI	150 PSI	175 PSI	250 PSI	300 PSI
1-ASL	1	7	12	14	15	N/A	N/A	N/A
2-ASL	2	18	23	41	43	59	65	74
2 1/2-ASL	2-1/2	18	23	50	54	70	80	90
3-ASL	3	18	24	56	60	80	90	100
4-ASL	4	23	25	66	79	92	105	118
5-ASL	5	26	40	175	195	266	280	315
6-ASL	6	28	45	190	210	330	350	400
8-ASL	8	34	57	350	400	490	560	630
10-ASL	10	42	63	700	750	950	1,120	1,260
12-ASL	12	48	82	912	990	1,200	1,460	1,640
14-ASL	14	58	102	1,853	2,150	2,800	2,965	3,335
16-ASL	16	66	104	2,610	3,600	4,060	4,175	4,700
18-ASL	18	66	114	2,900	4,000	4,600	5,100	5,400
20-ASL	20	72	110	4,560	5,800	6,500	7,300	8,200
22-ASL	22	72	126	5,320	6,000	7,000	8,500	9,575
24-ASL	24	84	147	6,175	7,000	8,500	9,880	11,000

PRICING: ASME MODELS

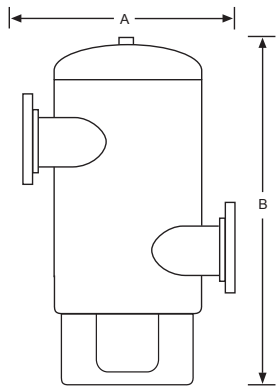

5-ASL THROUGH 24-ASL

Base Model Number	Part No. / List Price (USD)					
	125 PSI	150 PSI	175 PSI	250 PSI	300 PSI	
1-ASL	394020 / \$1,773	394022 / \$1,956	N/A	N/A	N/A	
2-ASL	394035 / \$2,011	394032 / \$2,209	420402 / \$2,812	394034 / \$3,212	417958 / \$3,612	
2 1/2-ASL	394051 / \$2,277	394046 / \$2,504	\$3,182	394049 / \$3,642	491-16 / \$4,091	
3-ASL	394083 / \$2,747	394071 / \$3,021	394075 / \$3,850	492-32 / \$4,394	492-28 / \$4,953	
4-ASL	394087 / \$3,203	394106 / \$3,521	430946 / \$4,490	394100 / \$5,128	394108 / \$5,770	
5-ASL	394113 / \$3,794	394126 / \$4,175	394124 / \$5,307	494-17 / \$6,073	\$6,831	
6-ASL	394155 / \$4,644	394149 / \$5,108	426899 / \$6,452	495-17 / \$7,426	\$8,374	
8-ASL	394186 / \$6,288	394176 / \$6,920	394170 / \$8,804	394169 / \$10,044	394178 / \$11,322	
10-ASL	394212 / \$10,879	394201 / \$11,967	427352 / \$15,243	417525 / \$17,394	497-21 / \$19,608	
12-ASL	394244 / \$12,549	394238 / \$13,821	413581 / \$17,552	392704 / \$20,082	392702 / \$22,549	
14-ASL	394315 / \$21,379	394308 / \$23,466	432668 / \$29,917	499-66 / \$34,155	\$38,488	
16-ASL	394288 / \$27,008	394309 / \$29,696	427299 / \$37,760	\$43,169	394389 / \$48,671	
18-ASL	400789 / \$40,765	394310 / \$44,876	\$57,052	\$65,211	\$73,370	
20-ASL	394290 / \$53,605	499-49 / \$58,981	\$75,078	437099 / \$85,830	\$96,520	
22-ASL	499-55 / \$62,207	499-31 / \$68,437	\$87,095	\$99,429	\$111,826	
24-ASL	394287 / \$71,409	499-50 / \$78,493	\$99,998	\$114,230	\$128,398	

Additional Options:

Standard Leadtime:

Connection:

Warranty:

Grooved Pipe Connectors (G): Available on models 2-ASL through 14-ASL. Consult factory for pricing.
 1-ASL through 12-ASL 125 & 150 PSI: 20 Days, 175 PSI: 30 Days, 250 & 300 PSI: 40 Days,
 14-ASL through 18-ASL: 30 Days, 20-ASL through 24-ASL: 60 Days.
 Add 10 days to Standard Leadtime for Grooved Pipe Connectors (G).
 125, 150, and 175 PSI: 150# flanges; 250 and 300 PSI: 300# flanges.
 1-Year Limited

APPLICATIONS & ORDERING

- For use in non-potable closed hydronic and chilled water systems.
- Choose from Tangential (vortex) or Inline (air scoop) styles.
- Constructed to ASME Section VIII, Division 1.

How to Order: Specify Model & Options

6-AS-125

Step 1: Select Base Model Number
Step 2: Choose Pressure Rating

6-Inch Air Separator With Strainer, 125 PSI Rating

TANGENTIAL AIR SEPARATORS, WITH STRAINER, ASME

J

TECHNICAL DATA

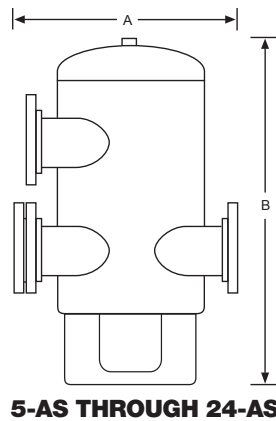
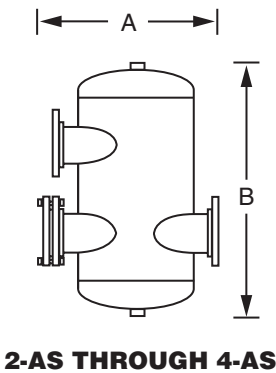

Base Model Number	Connection Size (In)	A Width (In)	B Height (In)	Shipping Weight (Lbs)				
				125 PSI	150 PSI	175 PSI	250 PSI	300 PSI
2-AS	2	18	23	45	47	63	72	81
2 1/2-AS	2-1/2	18	23	54	58	75	86	97
3-AS	3	18	24	60	64	84	96	108
4-AS	4	23	25	70	83	98	112	126
5-AS	5	26	40	200	220	280	320	360
6-AS	6	28	45	249	261	348	398	448
8-AS	8	34	57	375	445	525	600	675
10-AS	10	42	63	750	800	1,050	1,200	1,350
12-AS	12	48	82	950	1,060	1,330	1,520	1,710
14-AS	14	58	102	2,200	2,500	3,080	3,520	3,960
16-AS	16	66	104	3,000	3,900	4,200	4,800	5,400
18-AS	18	66	114	3,500	4,700	4,900	5,600	6,300
20-AS	20	72	110	5,000	6,100	7,000	8,000	9,000
22-AS	22	72	126	5,500	6,600	7,700	8,800	9,900
24-AS	24	84	147	7,000	8,400	9,800	11,200	12,600

PRICING: ASME MODELS

Base Model Number	Part No. / List Price (USD)				
	125 PSI	150 PSI	175 PSI	250 PSI	300 PSI
2-AS	398301 / \$2,253	394031 / \$2,589	425823 / \$3,150	\$3,596	\$4,058
2 1/2-AS	394052 / \$2,491	394045 / \$2,864	428622 / \$3,482	\$3,980	\$4,477
3-AS	394084 / \$3,338	394070 / \$3,835	394074 / \$4,667	394073 / \$5,337	410882 / \$6,008
4-AS	394088 / \$3,612	394105 / \$4,154	400948 / \$5,051	422704 / \$5,786	\$6,502
5-AS	394114 / \$4,845	394125 / \$5,575	\$6,780	\$7,754	494-16 / \$8,729
6-AS	394156 / \$6,010	394148 / \$6,907	394142 / \$8,425	495-31 / \$9,627	\$10,816
8-AS	394187 / \$7,754	394175 / \$8,931	394171 / \$10,866	424958 / \$12,410	496-36 / \$13,947
10-AS	394213 / \$13,219	394200 / \$15,212	394204 / \$18,501	497-20 / \$21,126	497-23 / \$23,814
12-AS	394245 / \$16,002	394237 / \$19,734	394240 / \$22,454	191-44 / \$25,648	498-23 / \$28,811
14-AS	394320 / \$26,692	394303 / \$30,676	499-69 / \$37,350	499-71 / \$42,694	499-74 / \$48,007
16-AS	394282 / \$33,080	394304 / \$37,982	394318 / \$46,268	502-2 / \$52,877	502-1 / \$59,518
18-AS	394296 / \$50,916	394305 / \$58,538	503-3 / \$71,346	503-1 / \$81,466	499-73 / \$91,586
20-AS	499-29 / \$66,982	394306 / \$77,039	504-2 / \$93,800	499-70 / \$107,209	499-72 / \$120,555
22-AS	499-35 / \$96,203	499-54 / \$110,814	\$134,849	\$154,077	\$173,558
24-AS	499-40 / \$109,486	499-45 / \$125,931	\$153,445	\$175,329	\$197,087

Additional Options: Grooved Pipe Connectors (G): Available on models 2-AS through 14-AS. Consult factory for pricing.
Standard Leadtime: 2-AS through 12-AS; 125 & 150 PSI: 20 Days, 175 PSI, 30 Days, 250 & 300 PSI: 40 Days, 14-AS through 18-AS: 30 Days, 20-AS through 24-AS: 60 Days.
 Add 10 days to Standard Leadtime for Grooved Pipe Connectors (G).
Connection: 125, 150, and 175 PSI: 150# flanges; 250 and 300 PSI: 300# flanges.
Warranty: 1-Year Limited

APPLICATIONS & ORDERING

- For use in closed, non-potable water systems.
- Eliminates entrained air and separates debris associated with start-up and maintenance of any hydronic system.
- Magnetic Separator option removes ferrous particles; includes dry well for ease of maintenance.
- Constructed to ASME Section VIII, Division 1.

How to Order: Specify Model & Options

4-ADS-125-M

- Step 1: Select Base Model Number
 Step 2: Choose Pressure Rating
 Step 3: Magnetic Separator Option

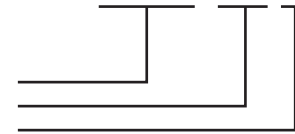

4-inch Air & Dirt Separator, 125 PSI Rating with Magnetic Separator

AIR & DIRT SEPARATORS, ASME

TECHNICAL DATA

Base Model Number	Connection Size (in)	A Width (in)	B Height (in)	Shipping Weight (Lbs)	
				125 PSI	150 PSI
2-ADS	2	15	23	60	65
3-ADS	3	20	29	92	97
4-ADS	4	21	29	102	110
5-ADS	5	28	42	144	154
6-ADS	6	28	42	149	159
8-ADS	8	34	49	258	270
10-ADS	10	38	64	384	395
12-ADS	12	43	75	533	550

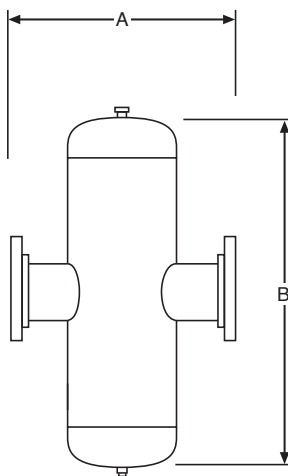

2-ADS THROUGH 12-ADS

PRICING: ASME MODELS

Base Model Number	Part No. / List Price (USD)	
	125 PSI	150 PSI
2-ADS	394539 / \$3,401	394540 / \$3,574
3-ADS	394541 / \$6,363	394545 / \$6,692
4-ADS	394542 / \$6,932	394547 / \$7,286
5-ADS	394543 / \$9,753	394549 / \$10,272
6-ADS	394544 / \$11,967	394550 / \$12,587
8-ADS	394546 / \$24,636	394551 / \$25,933
10-ADS	394548 / \$37,760	411423 / \$39,753
12-ADS	411428 / \$51,106	394559 / \$53,795
Magnetic Replacement Kit 2-ADS-4-ADS		427221 / \$1,518
Magnetic Replacement Kit 5-ADS-12-ADS		427222 / \$1,898

Additional Options: Grooved Pipe Connectors (G): Available on models 2-ADS through 12-ADS.

Magnetic Upgrade (M): 2-ADS through 4-ADS: \$944, 5-ADS through 12-ADS: \$1,289

Grooved Connections (G): Consult factory for pricing.

Standard Leadtime: 2-ADS through 12-ADS: 30 Days. Add 10 days to Standard Leadtime for Grooved Pipe Connectors (G).

Connection: 125 and 150 PSI: 150# flanges.

Warranty: 1-Year Limited.

INLINE AIR PURGERS

- Eliminate air in closed hydronic or chilled water systems.

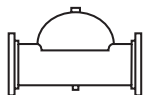

Model Number	Connection Size (in)	Shipping Weight (Lbs)		Part No. / List Price (USD)	
		125 PSI	150 PSI	125 PSI	150 PSI
449*	4	56	NA	393997 / \$806	NA
461*	5	NA	60	NA	393998 / \$2,983
462*	6	NA	65	NA	393999 / \$3,220
463*	8	NA	113	NA	394000 / \$4,309
464*	10	NA	174	NA	394001 / \$6,831
465*	12	NA	330	NA	394002 / \$8,172
466*	14	NA	500	NA	394004 / \$13,030
467	16	NA	231	NA	394006 / \$14,833 *150 PSI ANSI Flanges
468	18	NA	573	NA	394009 / \$17,110

Standard Leadtime: 449 through 465: 10 Days, 466 through 468: 30 Days.

Warranty: 1-Year Limited

Air Vents & Plain Steel Tanks

HIGH CAPACITY AIR VENT

J

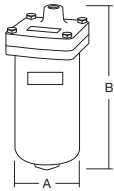

Model Number	Part No. / Description	A Diameter (In)	B Height (In)	Shipping Weight (Lbs)	List Price (USD)
747	390014 / High Capacity Vent	4	10	8	\$1,467
	Repair Kit 390060 / Repair Kit & Gasket Assy			1	\$243

For venting air from closed hydronic or chilled water systems.
Standard Leadtime: Vent and Repair Kit: 10 Days
Warranty: 1-Year Limited

AC MODELS: PLAIN STEEL COMPRESSION TANKS, ASME

J

PRICING: ASME MODELS

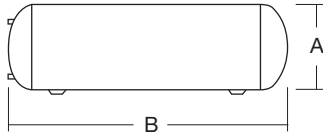

AC12-15 THROUGH AC36-505

Model Number	Volume (Gal)	A-Diameter (In)	B-Length (In)	Shipping Weight (Lbs)		Part No. / List Price (USD)	
				125 PSIG	150 PSIG	125 PSIG	150 PSIG
AC12-15	15	12	33	NA	44	NA	392213 / 1,374
AC12-24	24	12	51	NA	62	NA	392214 / \$1,444
AC14-30	30	14	48	NA	72	NA	392215 / \$1,758
AC14-40	40	14	63	NA	92	NA	392216 / \$2,045
AC16-60	60	16	72	NA	120	NA	392217 / \$2,381
AC20-80	80	20	63	136	NA	392218 / \$2,387	NA
AC20-100	100	20	78	168	NA	392219 / \$3,565	NA
AC24-120	120	24	65	218	NA	392220 / \$4,453	NA
AC24-135	135	24	72	238	NA	392221 / \$4,591	NA
AC30-175	175	30	62	338	NA	392222 / \$6,856	NA
AC30-220	220	30	77	368	NA	400774 / \$8,045	NA
AC30-240	240	30	84	394	NA	183-8025 / \$8,197	NA
AC30-305	305	30	106	486	NA	392225 / \$8,589	NA
AC36-400	400	36	93	645	NA	183-8028 / \$8,944	NA
AC36-505	505	36	120	810	NA	392227 / \$9,804	NA

Maximum Operating Temperature: 450° F

For use in closed hydronic and chilled water systems.
Standard Leadtime: AC12-15 through AC30-305: 20 days. AC36-400 and AC36-505: 30 days.
Working Pressure: AC12-15 through AC16-60:150 PSI. AC20-80 through AC36-505: 125 PSI.
Warranty: 1-Year Limited

APPLICATIONS & ORDERING

- For use in non-potable closed chilled water systems.
- Available with 3" to 12" connections.
- Constructed to ASME Section VIII, Division 1.

How to Order: Specify Model & Options

CWBT500-6-125 R

- Step 1: Select Base Model Number
 Step 2: Specify Sensor Ports
 Step 3: Specify Restraint Option (or leave blank)

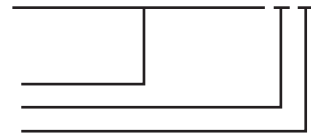

CWBT500-6 125 PSI Rating with Restraints

CWBT MODELS: CHILLED WATER BUFFER TANKS, ASME

TECHNICAL DATA

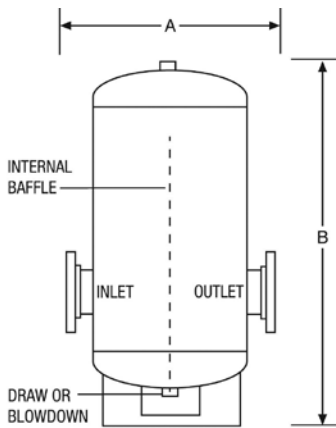

CWBT120 THROUGH CWBT1040

Base Model Number	Volume (Gal)	A Width (In)	B Height (In)	Connection Size (In)	Shipping Weight (Lbs)	
					125 PSI	150 PSI
CWBT120-3	120	33	56	3	294	323
CWBT120-4	120	33	56	4	315	347
CWBT120-6	120	33	56	6	333	366
CWBT200-3	200	39	63	3	527	580
CWBT200-4	200	39	63	4	547	602
CWBT200-6	200	39	63	6	566	623
CWBT300-4	300	45	80	4	753	828
CWBT300-6	300	45	80	6	772	849
CWBT300-8	300	45	80	8	801	881
CWBT500-6	500	51	99	6	1,366	1,503
CWBT500-8	500	51	99	8	1,395	1,535
CWBT500-10	500	51	99	10	1,490	1,639
CWBT850-6	850	64	115	6	2,707	2,978
CWBT850-8	850	64	115	8	2,736	3,010
CWBT850-10	850	64	115	10	2,771	3,048
CWBT1040-8	1040	70	108	8	3,136	3,450
CWBT1040-10	1040	70	108	10	3,171	3,488
CWBT1040-12	1040	70	108	12	3,283	3,611

PRICING: ASME MODELS

Base Model Number	Part No. / List Price (USD)	
	125 PSI	150 PSI
CWBT120-3	394402 / \$6,831	394448 / \$8,185
CWBT120-4	394403 / \$7,173	394439 / \$8,615
CWBT120-6	411257 / \$7,818	517-49 / \$9,374
CWBT200-3	394405 / \$8,944	394457 / \$10,727
CWBT200-4	394406 / \$9,399	407429 / \$11,309
CWBT200-6	394407 / \$10,297	400949 / \$12,372
CWBT300-4	394408 / \$11,246	412541 / \$13,504
CWBT300-6	394409 / \$11,802	\$14,168
CWBT300-8	438419 / \$12,935	394447 / \$15,528
CWBT500-6	394411 / \$21,727	394454 / \$26,091
CWBT500-8	436210 / \$22,802	436210 / \$27,356
CWBT500-10	517-12 / \$25,016	\$30,013
CWBT850-6	394433 / \$32,384	394445 / \$38,899
CWBT850-8	394434 / \$34,061	\$40,923
CWBT850-10	394435 / \$37,286	\$44,750
CWBT1040-8	394436 / \$43,042	426328 / \$51,707
CWBT1040-10	517-17 / \$45,161	\$54,205
CWBT1040-12	517-18 / \$49,494	\$59,455

Additional Options: Add to Base Model List Price
Seismic Restraints (R): \$339
Sensor Ports (SP): \$482
Grooved Pipe Connectors (G): Consult factory for pricing.

Standard Leadtime: CWBT120-3 through CWBT300-8: 20 Days; CWBT500-6 through CWBT1040-12: 40 Days; Add 10 days to Standard Leadtime for Grooved Pipe Connectors (G).

Connection: 125 and 150 PSI: 150# flanges.

Warranty: 1-Year Limited

APPLICATIONS & ORDERING

- For use in non-potable closed heating systems.
- Available with 2" to 4" connections.
- Constructed to ASME Section VIII, Division 1.
- Maximum Operating Temperature: 450° F.

How to Order: Specify Model & Options

HWBT120-2-125SPR

- Step 1: Select Base Model Number
 Step 2: Specify Sensor Ports
 Step 3: Specify Restraint Option (or leave blank)



HWBT120-2 125 PSI Rating with Sensor Ports and Restraints

HWBT MODELS: HOT WATER BUFFER TANKS, ASME

J

TECHNICAL DATA

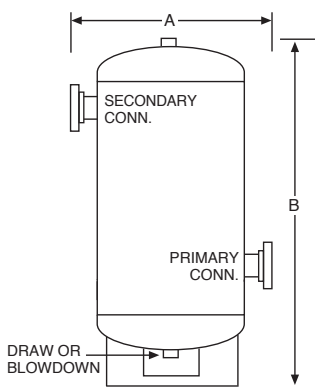

**HWBT120-2 THROUGH
HWBT300-3**

Base Model Number	Volume (Gal)	A Width (In)	B Height (In)	Primary Connection Size (In)	Secondary Connection Size (In)	Shipping Weight (Lbs)	
						125 PSI	150 PSI
HWBT120-2	120	33	56	2	2	254	279
HWBT120-3	120	33	56	3	3	268	295
HWBT200-2	200	39	63	2	2	475	523
HWBT200-3	200	39	63	3	3	490	539
HWBT300-2	300	45	80	2	2	668	735
HWBT300-3	300	45	80	3	3	683	751
HWBT120-2/2	120	33	56	2	2	267	294
HWBT120-2/3	120	33	56	2	3	282	310
HWBT120-3/3	120	33	56	3	3	297	327
HWBT120-4/4	120	33	56	4	4	338	372
HWBT200-2/2	200	39	63	2	2	489	538
HWBT200-2/3	200	39	63	2	3	503	553
HWBT200-3/3	200	39	63	3	3	518	570
HWBT200-4/4	200	39	63	4	4	560	617
HWBT300-2/2	300	45	80	2	2	682	750
HWBT300-2/3	300	45	80	2	3	696	766
HWBT300-3/3	300	45	80	3	3	711	782
HWBT300-4/4	300	45	80	4	4	753	828

PRICING: ASME MODELS

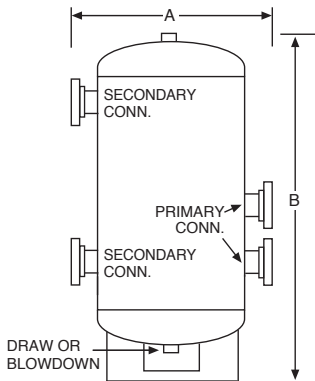

**HWBT120-2/2 THROUGH
HWBT300-4/4**

Base Model Number	Part No. / List Price (USD)	
	125 PSI	150 PSI
HWBT120-2	394575 / \$5,753	419766 / \$6,907
HWBT120-3	394576 / \$6,119	430474 / \$7,350
HWBT200-2	394583 / \$7,717	\$9,272
HWBT200-3	394584 / \$7,995	394591 / \$9,601
HWBT300-2	527-301 / \$10,272	\$12,334
HWBT300-3	425223 / \$10,639	\$12,777
HWBT120-2/2	394577 / \$7,615	423870 / \$9,133
HWBT120-2/3	394578 / \$7,932	\$9,525
HWBT120-3/3	394579 / \$8,260	\$9,905
HWBT120-4/4	394580 / \$8,589	\$10,284
HWBT200-2/2	394585 / \$9,500	413981 / \$11,398
HWBT200-2/3	527-204 / \$9,816	\$11,777
HWBT200-3/3	394587 / \$10,145	394590 / \$12,169
HWBT200-4/4	394588 / \$10,449	422622 / \$12,549
HWBT300-2/2	527-303 / \$12,144	\$14,548
HWBT300-2/3	413773 / \$12,448	\$14,959
HWBT300-3/3	413990 / \$12,777	394604 / \$15,307
HWBT300-4/4	394600 / \$13,219	416831 / \$15,845

- Additional Options:** Add to Base Model List Price
Seismic Restraints (R): \$339
Sensor Ports (SP): \$482
Grooved Pipe Connectors (G): Consult factory for pricing.

- Standard Leadtime:** All Models 10 days.
 Add 10 days to Standard Leadtime for Grooved Pipe Connectors (G).
Connection: 125 and 150 PSI: 150# flanges.
Warranty: 1-Year Limited

APPLICATIONS & ORDERING

- For use in potable hot water systems.
- Antimicrobial/ASHRAE 188 Anti-Legionella Liner.
- Fixed diaphragm construction.
- Deep Drawn models are lighter, stronger and more compact than traditional head and shell construction.
- Constructed to ASME Section VIII, Division 1.
- Maximum Operating Temperature: 200° F.
- Patented Turbulator.

How to Order: Specify Model & Options

ST-80VC-150SGR

- Step 1: Select Base Model Number
 Step 2: Choose Pressure Rating
 Step 3: Specify Sight Glass Option (or leave blank)
 Step 4: Specify Restraint Option (or leave blank)

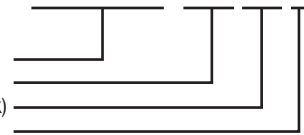

ST-80VC 150 PSI Rating with Sight Glass & Restraints

ST MODELS: DEEP DRAWN, DIAPHRAGM TYPE, ASME

J

TECHNICAL DATA

Base Model Number	Volume (Gal)	Max Acceptance Volume (Gal)	A-Diameter (In)	B-Height (In)	Shipping Weight (Lbs)			
					150 PSI	175 PSI	250 PSI	300 PSI
ST-5C-DD	2.0	0.9	8	14	10	12	NA	NA
ST-12C-DD	6.4	3.2	12	18	26	28	NA	NA
ST-20VC-DD	8.6	3.2	12	22	36	38	NA	NA
ST-30VC-DD	16.6	11.3	15	25	48	NA	NA	NA
ST-42VC-DD	23.2	11.3	15	33	68	NA	NA	NA

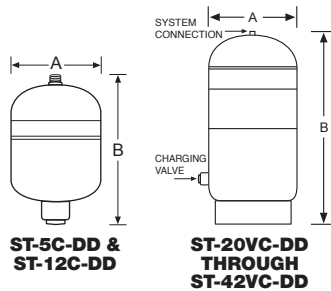

ST-5C-DD & ST-12C-DD

ST-20VC-DD THROUGH ST-42VC-DD

PRICING: DEEP DRAWN, DIAPHRAGM TYPE, ASME MODELS

Base Model Number	Part No. / List Price (USD)			
	150 PSI	175 PSI	250 PSI	300 PSI
ST-5C-DD	390414 / \$2,505	390413 / \$2,754	NA	NA
ST-12C-DD	390602 / \$3,272	390601 / \$3,596	NA	NA
ST-20VC-DD	390603 / \$3,401	401796 / \$3,741	NA	NA
ST-30VC-DD	401681 / \$3,840	NA	NA	NA
ST-42VC-DD	401800 / \$4,101	NA	NA	NA

ST MODELS: HEAD & SHELL, DIAPHRAGM TYPE, ASME

J

TECHNICAL DATA

Base Model Number	Volume (Gal)	Max Acceptance Volume (Gal)	A-Diameter (In)	B-Height (In)	Shipping Weight (Lbs)			
					150 PSI	175 PSI	250 PSI	300 PSI
ST-5C	2.1	0.9	10	10	NA	NA	25	30
ST-12C	6.4	3.2	12	14	NA	NA	42	50
ST-20VC	8.0	3.2	12	19	NA	NA	50	62
ST-30VC	14.0	9.0	16	19	NA	64	96	108
ST-42VC	18.0	11.0	16	24	NA	75	101	112
ST-60VC	25.0	11.0	16	32	85	113	125	139
ST-70VC	34.0	11.0	16	45	99	122	136	151
ST-80VC	53.0	35.0	24	37	224	296	305	340
ST-120VC	68.0	35.0	24	44	266	340	375	400
ST-180VC	77.0	35.0	24	49	285	360	380	420
ST-210VC	90.0	35.0	24	57	319	380	405	440

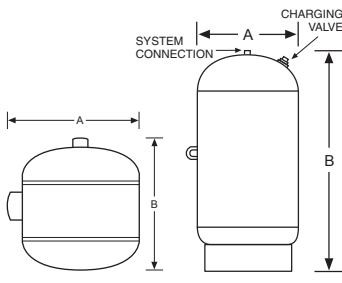

ST-5C & ST-12C

ST-20VC THROUGH ST-70VC

PRICING: HEAD & SHELL, DIAPHRAGM TYPE, ASME MODELS

Base Model Number	Part No. / List Price (USD)			
	150 PSI	175 PSI	250 PSI	300 PSI
ST-5C	NA	NA	390525 / \$3,176	390516 / \$3,495
ST-12C	NA	NA	390651 / \$4,150	390652 / \$4,566
ST-20VC	NA	NA	390779 / \$4,316	390784 / \$4,747
ST-30VC	NA	391274 / \$4,429	390847 / \$4,870	390852 / \$5,356
ST-42VC	NA	391275 / \$4,731	390960 / \$5,204	\$5,725
ST-60VC	435465 / \$4,993	391255 / \$5,494	403070 / \$6,043	435598 / \$6,654
ST-70VC	391251 / \$5,158	391271 / \$5,674	391273 / \$6,240	401860 / \$6,856
ST-80VC	391323 / \$7,362	391355 / \$8,109	391337 / \$8,918	391347 / \$9,829
ST-120VC	391331 / \$7,729	147-240 / \$8,526	391357 / \$9,361	391348 / \$10,297
ST-180VC	391441 / \$8,058	391457 / \$8,880	391459 / \$9,766	\$10,753
ST-210VC	391442 / \$8,463	391458 / \$9,323	391460 / \$10,247	401266 / \$11,271

Additional Options: Add to Base Model List Price

Sight Glass (SG): \$482

Seismic Restraints (R): \$339

Standard Leadtime:

ST-5C-DD, ST-12C-DD and ST-20VC-DD 150 PSI: Up to 5 units – 5 Days; Over 5 units – 10 Days.

All other ST models 150 PSI: 10 Days, 175 PSI: 20 Days, 250 PSI: 30 Days, 300 PSI: 40 Days

Connection:

Stainless Steel: DD ST-5C, ST-12C, ST-20VC, ST-30VC and ST-42VC: 3/4" NPTM

Non-DD ST-5C, ST-12C, ST-20VC, ST-30VC and ST-42VC: 3/4" NPTF

ST-60VC and ST-70VC: 3/4" NPTF, ST-80VC through ST-210VC: 1 1/4" NPTF

All models: 55 PSI

Factory Precharge:

1-Year Limited

Warranty:

www.amtrol.com

REV-B Effective June 15, 2022



APPLICATIONS & ORDERING

- For use in potable hot water systems.
- Replaceable bladder construction.
- Maximum Operating Temperature: 240° F.

How to Order: Specify Model & Options

ST-448C-125SGR

- Step 1: Select Base Model Number
 Step 2: Choose Pressure Rating
 Step 3: Specify Sight Glass Option (or leave blank)
 Step 4: Specify Restraint Option (or leave blank)

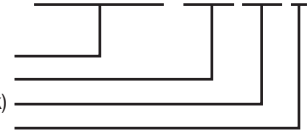

ST-448C 125 PSI Rating with Sight Glass & Restraints

ST-C MODELS: FULL ACCEPTANCE BLADDER, ASME J

TECHNICAL DATA

Base Model Number	Volume (Gal)	Max Acceptance Volume (Gal)	A Diameter (In)	B Height (In)	Shipping Weight (Lbs)				
					125 PSI	150 PSI	175 PSI	250 PSI	300 PSI
ST-447C	53	53	24	45	236	262	290	370	425
ST-448C	80	80	24	59	274	340	430	492	540
ST-449C	106	106	24	73	320	360	450	510	560
ST-450C	132	132	24	87	354	400	460	570	632
ST-451C	158	158	30	73	494	587	680	815	895
ST-452C	211	211	30	91	593	625	699	1,005	1,107
ST-453C	264	264	36	86	667	760	845	1,100	1,205
ST-454C	317	317	36	98	762	850	960	1,265	1,400
ST-455C	370	370	36	110	842	935	1,065	1,350	1,490
ST-456C	422	422	48	82	1,152	1,423	1,650	1,660	1,830
ST-457C	528	528	48	97	1,335	1,505	1,875	2,230	2,455

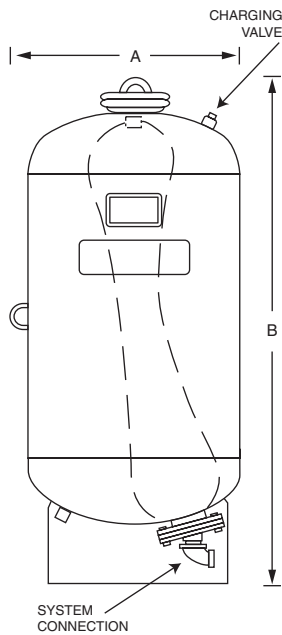

ST-447C THROUGH ST-457C

PRICING: ASME MODELS

Base Model Number	Part No. / List Price (USD)				
	125 PSI	150 PSI	175 PSI	250 PSI	300 PSI
ST-447C	392172 / \$9,956	392195 / \$10,955	417979 / \$12,599	392199 / \$14,484	\$16,667
ST-448C	392173 / \$11,562	392196 / \$12,713	392246 / \$13,978	401268 / \$15,433	\$16,951
ST-449C	392174 / \$13,472	392197 / \$14,833	392247 / \$16,319	392185 / \$17,963	183-127 / \$19,703
ST-450C	392180 / \$15,370	392198 / \$16,920	417675 / \$18,596	392138 / \$20,430	392139 / \$22,454
ST-451C	392307 / \$17,078	392324 / \$18,817	413774 / \$20,683	409433 / \$22,739	392333 / \$24,984
ST-452C	392360 / \$18,785	392373 / \$20,652	425072 / \$22,739	392362 / \$24,953	\$27,483
ST-453C	392418 / \$22,138	392432 / \$24,288	403073 / \$26,755	\$29,411	\$32,321
ST-454C	422691 / \$22,770	392036 / \$25,016	433163 / \$27,577	413074 / \$30,297	\$33,302
ST-455C	392054 / \$24,700	392060 / \$27,134	\$29,886	\$32,890	\$36,116
ST-456C	408015 / \$32,416	392502 / \$35,736	\$39,310	412377 / \$43,263	\$47,501
ST-457C	392547 / \$34,661	390312 / \$38,172	\$43,611	423762 / \$46,205	\$50,759

- Additional Options:** Add to Base Model List Price
Sight Glass (SG): \$482
Seismic Restraints (R): \$339
Stainless Steel Elbow: 2" \$960; 3" \$1,958; 4" \$2,847

- Standard Leadtime:** 125 & 150 PSI: 10 Days, 175 PSI: 30 Days, 250 & 300 PSI: 40 Days
Connection (NPTF): Bronze: ST-447C through ST-452C: 2", ST-453C through ST-457C: 3"
Factory Precharge: All models: 25 PSI
Warranty: 1-Year Limited



APPLICATIONS & ORDERING

- For use in potable hot water systems.
- Replaceable diaphragm construction.
- Maximum Operating Temperature: 240° F.

How to Order: Specify Model & Options

ST-100CL-150SGR

- Step 1: Select Base Model Number
 Step 2: Choose Pressure Rating
 Step 3: Specify Sight Glass Option (or leave blank)
 Step 4: Specify Restraint Option (or leave blank)

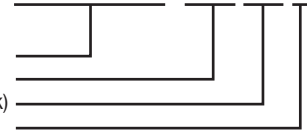

ST-100CL 150 PSI Rating with Sight Glass & Restraints

ST-CL MODELS: PARTIAL ACCEPTANCE BLADDER, ASME

J

TECHNICAL DATA

Base Model Number	Volume (Gal)	Max Acceptance Volume (Gal)	A Diameter (In)	B Height (In)	Shipping Weight (Lbs)
ST-35LCL	10	10	10	37	76
ST-50LCL	13	11	12	37	78
ST-85LCL	22	11	16	35	95
ST-100LCL	26	11	16	39	102
ST-130LCL	34	27	20	35	134
ST-165LCL	44	27	20	40	153
ST-200LCL	53	27	24	41	205
ST-300LCL	80	27	24	56	254
ST-400LCL	106	53	24	69	308
ST-500LCL	132	53	24	83	352
ST-600LCL	158	53	30	67	442

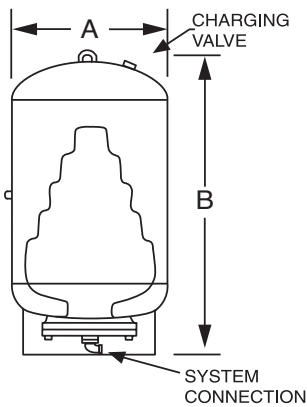

ST-35CL THROUGH ST-600CL

PRICING: ASME MODELS

Base Model Number	Part No. / List Price (USD) 150 PSI
ST-35CL	391656 / \$6,793
ST-50CL	391686 / \$6,882
ST-85CL	391716 / \$7,059
ST-100CL	391733 / \$7,135
ST-130CL	391747 / \$7,501
ST-165CL	391761 / \$7,767
ST-200CL	392698 / \$8,020
ST-300CL	392753 / \$8,311
ST-400CL	392779 / \$9,627
ST-500CL	392805 / \$9,994
ST-600CL	391804 / \$12,271

Additional Options: Add to Base Model List Price
Sight Glass (SG): \$482
Seismic Restraints (R): \$339

Standard Leadtime: All models 10 Days
Connection (NPTF): Stainless Steel: All Models: 1"
Factory Precharge: All models: 25 PSI
Warranty: 1-Year Limited



APPLICATIONS & ORDERING

- For use in water well and booster pump applications.
- Antimicrobial/ASHRAE 188 Anti-Legionella Liner.
- Fixed diaphragm construction.
- Deep Drawn models are lighter, stronger and more compact than traditional head and shell construction.
- Constructed to ASME Section VIII, Division 1.
- Maximum Operating Temperature: 200° F.
- Patented Turbulator.

How to Order: Specify Model & Options

WX-403C-125SGR

- Step 1: Select Base Model Number
- Step 2: Choose Pressure Rating
- Step 3: Specify Sight Glass Option (or leave blank)
- Step 4: Specify Restraint Option (or leave blank)

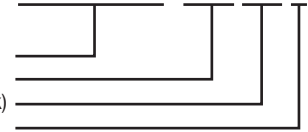

WX-403C (ASME) 125 PSI Rating with Sight Glass & Restraints

WX-C MODELS: DEEP DRAWN, DIAPHRAGM TYPE, ASME

		TECHNICAL DATA			Shipping Weight (Lbs)		
Base Model Number	Volume (Gal)	Max Acceptance Volume (Gal)	A Diameter (In)	B Height (In)	125 PSI	150 PSI	175 PSI
WX-101C-DD	2.0	0.9	8	14	10	10	12
WX-102C-DD	6.4	3.2	12	18	26	26	28
WX-103C-DD	8.6	3.2	12	22	36	36	38

		PRICING: DEEP DRAWN, DIAPHRAGM TYPE, ASME MODELS		
Base Model Number	125 PSI	150 PSI	175 PSI	Part No. / List Price (USD)
WX-101C-DD	423666 / \$ 2,391	\$ 2,593	436209 / \$ 2,783	
WX-102C-DD	423667 / \$ 3,163	436440 / \$ 3,302	\$ 3,706	
WX-103C-DD	423668 / \$ 3,289	\$ 3,428	\$ 3,820	

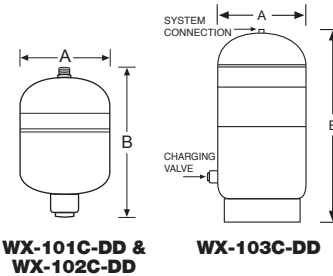

WX-C MODELS: HEAD & SHELL, DIAPHRAGM TYPE, ASME

		TECHNICAL DATA			Shipping Weight (Lbs)				
Base Model Number	Volume (Gal)	Max Acceptance Volume (Gal)	A Diameter (In)	B Height (In)	125 PSI	150 PSI	175 PSI	250 PSI	300 PSI
WX-401C	18	11	16	31	77	96	110	126	133
WX-402C	25	11	16	40	93	113	125	145	160
WX-403C	34	11	16	49	115	120	145	183	200
WX-404C	68	34	24	48	227	232	313	411	432
WX-405C	90	34	24	59	252	255	384	433	460
WX-406C	110	34	24	70	286	335	402	475	500
WX-407C	132	46	30	57	436	450	510	570	625

		PRICING: HEAD & SHELL, DIAPHRAGM TYPE, ASME				
Base Model Number	125 PSI	150 PSI	175 PSI	250 PSI	300 PSI	Part No. / List Price (USD)
WX-401C	429390 / \$3,888	429391 / \$4,279	390950 / \$4,707	390997 / \$5,178	390998 / \$5,695	
WX-402C	429392 / \$4,462	429394 / \$4,907	391122 / \$5,398	391126 / \$5,937	391081 / \$6,527	
WX-403C	429397 / \$4,859	429422 / \$5,348	391245 / \$5,882	391246 / \$6,477	391768 / \$7,109	
WX-404C	435433 / \$7,211	391344 / \$7,919	391320 / \$8,729	391319 / \$9,614	391770 / \$10,563	
WX-405C	391513 / \$7,539	391492 / \$8,311	391511 / \$9,121	391510 / \$10,044	391772 / \$11,056	
WX-406C	391484 / \$7,906	391493 / \$8,716	391489 / \$9,601	391497 / \$10,537	149-169 / \$11,613	
WX-407C	391485 / \$8,931	391494 / \$9,854	391496 / \$10,828	391490 / \$11,916	391507 / \$13,093	

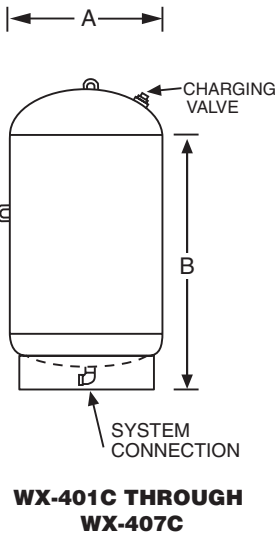

Additional Options: Add to Base Model List Price
Sight Glass (SG): \$482
Seismic Restraints (R): \$339

Standard Leadtime: 125 & 150 PSI: 10 days, 175 PSI: 20 days, 250 & 300 PSI: 30 days,
Connection: Stainless Steel: WX-101C-DD through WX-103C-DD: 3/4" NPTM, Malleable Iron: WX-401C through WX-403C: 1", WX-404C through WX-407C: 1-1/4" NPTF
Factory Precharge: All models: 25 PSI
Warranty: 1-Year Limited



APPLICATIONS & ORDERING

- For use in water well and booster pump applications.
- Replaceable bladder design.
- Maximum Operating Temperature: 240° F.

How to Order: Specify Model & Options

WX-448C-175SGR

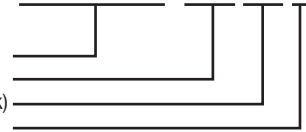

- Step 1: Select Base Model Number
 Step 2: Choose Pressure Rating
 Step 3: Specify Sight Glass Option (or leave blank)
 Step 4: Restraint Option (or leave blank)

WX-448C (ASME) 175 PSI Rating with Sight Glass & Restraints

WX-C MODELS: FULL ACCEPTANCE BLADDER, ASME

J

TECHNICAL DATA

Base Model Number	Volume (Gal)	Max Acceptance Volume (Gal)	A Diameter (In)	B Height (In)	Shipping Weight (Lbs)				
					125 PSI	150 PSI	175 PSI	250 PSI	300 PSI
WX-447C	53	53	24	45	263	289	368	420	462
WX-448C	80	80	24	59	315	338	430	492	540
WX-449C	106	106	24	73	319	350	440	507	557
WX-450C	132	132	24	87	351	392	454	570	627
WX-451C	158	158	30	73	493	587	680	813	894
WX-452C	211	211	30	91	602	627	694	1,007	1,107
WX-453C	264	264	36	86	676	752	846	1,095	1,204
WX-454C	317	317	36	98	762	840	959	1,264	1,390
WX-455C	370	370	36	110	843	930	1,060	1,350	1,485
WX-456C	422	422	48	82	1,154	1,418	1,655	1,700	1,826
WX-457C	528	528	48	97	1,331	1,500	1,870	2,365	2,450
WX-458C	660	660	60	84	1,450	1,740	2,030	2,320	2,750
WX-459C	792	792	60	99	2,169	2,385	3,036	3,470	3,690
WX-460C	925	925	60	107	2,300	2,530	3,220	3,680	3,910
WX-461C	1,056	1,056	60	121	2,638	2,900	3,695	4,220	4,485
WX-462C	1,320	1,320	72	108	3,500	3,850	4,900	5,600	5,950
WX-463C	1,980	1,980	72	140	4,100	4,510	5,740	6,560	6,970

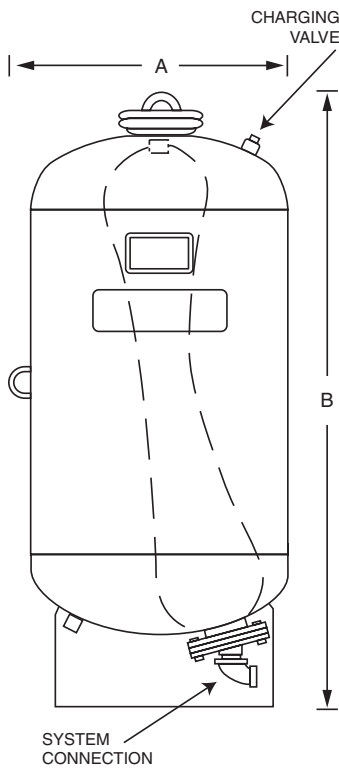

PRICING: ASME MODELS

Base Model Number	Part No. / List Price (USD)				
	125 PSI	150 PSI	175 PSI	250 PSI	300 PSI
WX-447C	392152 / \$10,980	392191 / \$12,068	392165 / \$13,283	392156 / \$14,643	392126 / \$16,034
WX-448C	392153 / \$11,043	392192 / \$12,144	392170 / \$13,346	392157 / \$14,706	392120 / \$16,161
WX-449C	392151 / \$11,486	392193 / \$12,650	407471 / \$13,884	392158 / \$15,275	410876 / \$16,825
WX-450C	392154 / \$11,954	392194 / \$13,156	392101 / \$14,421	392159 / \$15,908	392181 / \$17,489
WX-451C	392306 / \$14,864	392325 / \$16,414	392309 / \$18,058	392310 / \$19,893	392329 / \$21,821
WX-452C	392359 / \$16,445	392374 / \$18,122	392363 / \$19,924	392364 / \$21,917	438324 / \$24,098
WX-453C	392417 / \$20,082	392433 / \$22,043	392420 / \$24,225	402640 / \$26,724	428868 / \$29,380
WX-454C	392029 / \$21,379	392037 / \$23,466	392032 / \$25,775	392033 / \$28,399	\$31,278
WX-455C	392053 / \$22,676	392061 / \$24,889	419862 / \$27,387	182-42 / \$30,076	\$33,112
WX-456C	392494 / \$28,748	392501 / \$31,657	435432 / \$34,788	392498 / \$38,298	438164 / \$42,125
WX-457C	392546 / \$31,341	392558 / \$34,471	419557 / \$37,950	435449 / \$41,682	436124 / \$45,920
WX-458C	392561 / \$35,768	392570 / \$39,405	\$42,757	\$47,627	392541 / \$56,735
WX-459C	392562 / \$41,872	392588 / \$46,015	\$50,600	188-94 / \$55,660	*
WX-460C	392563 / \$50,790	\$55,882	\$61,511	\$67,678	*
WX-461C	392564 / \$56,356	429344 / \$61,954	\$68,120	\$75,015	*
WX-462C	392565 / \$84,565	\$92,914	\$102,339	*	*
WX-463C	392587 / \$149,144	436570 / \$163,944	*	*	*

* Consult Amtrol Customer Service for List Price and Lead Times.

- Standard Leadtime:** WX-447C through WX-457C, 125 & 150 PSI: 10 Days, 175 PSI: 30 Days, 250 PSI: 40 Days, 300 PSI: 50 Days. WX-458C through WX-463C, All pressures: 50 Days.
- Connection (NPTF):** Malleable Iron: WX-447C through WX-452C: 2", WX-453C through WX-457C: 3", WX-458C through WX-463C: 4"
- Factory Precharge:** All models: 25 PSI
- Warranty:** 1-Year Limited

- Additional Options:** Add to Base Model List Price
- Sight Glass (SG):** \$482
- Seismic Restraints (R):** \$339
- Stainless Steel Elbow:** 2" \$960; 3" \$1,958; 4" \$2,847



WX 447C THROUGH WX-463C

TECHNICAL DATA

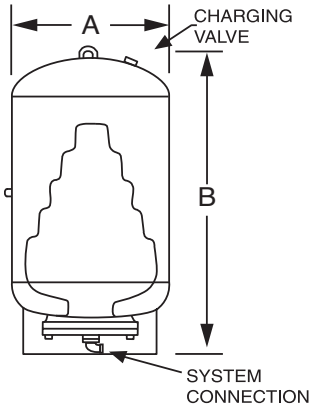

WX-35CL THROUGH WX-600CL

Base Model Number	Volume (Gal)	Max Acceptance Volume (Gal)	A Diameter (In)	B Height (In)	Shipping Weight (Lbs)
WX-35CL	10	10	10	37	69
WX-50CL	13	11	12	37	76
WX-85CL	22	11	16	35	92
WX-100CL	26	11	16	39	98
WX-130CL	34	27	20	35	136
WX-165CL	44	27	20	40	146
WX-200CL	53	27	24	41	198
WX-300CL	80	27	24	56	236
WX-400CL	106	53	24	69	282
WX-500CL	132	53	24	83	316
WX-600CL	158	53	30	67	450

PRICING: ASME MODELS

Base Model Number	Part No. / List Price (USD)
	125 PSI
WX-35CL	407286 / \$6,818
WX-50CL	408763 / \$6,920
WX-85CL	167-7 / \$7,097
WX-100CL	418391 / \$7,160
WX-130CL	408539 / \$7,464
WX-165CL	391763 / \$7,552
WX-200CL	392700 / \$7,818
WX-300CL	392755 / \$8,172
WX-400CL	392781 / \$9,563
WX-500CL	392807 / \$9,880
WX-600CL	391806 / \$12,524

Additional Options: Add to Base Model List Price
Sight Glass (SG): \$482
Seismic Restraints (R): \$339

Standard Leadtime: All models 10 Days
Connection (NPTF): Malleable Iron: WX-35CL through WX-100CL: 1-1/4", WX-130CL through WX-300CL: 1-1/2", WX-400CL through WX-600CL: 2"
Factory Precharge: All models: 25 PSI
Warranty: 1-Year Limited

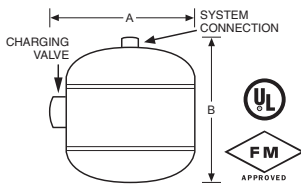
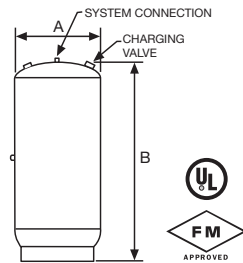
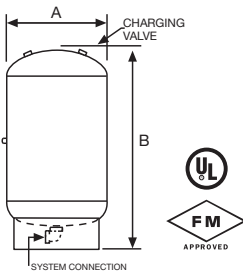

FPT MODELS: FIRE-X-TROL® SPRINKLER SYSTEM EXPANSION TANKS, 175 PSI, AMSE

F

FPT-5C THROUGH FPT-12C

FPT-20VC THROUGH FPT-70VC

FPT-80VC THROUGH FPT-210VC

TECHNICAL DATA

Model Number	Volume (Gal)	Max Acceptance Volume (Gal)	A Diameter (In)	B Height (In)	Sys. Conn. (In) St. Steel NPTF	Shipping Weight (Lbs)
FPT-5C	2.1	0.9	10	10	3/4	21
FPT-12C	6.4	3.2	12	16	3/4	36
FPT-20VC	8.0	3.2	12	20	3/4	52
FPT-30VC	14.0	9.0	16	19	3/4	97
FPT-42VC	17.5	11.0	16	24	3/4	116
FPT-60VC	25.0	11.0	16	33	3/4	154
FPT-70VC	34.0	11.0	16	42	3/4	197
FPT-80VC	53.0	35.0	24	36	1 1/4	251
FPT-120VC	66.0	35.0	24	44	1 1/4	281
FPT-180VC	77.0	35.0	24	49	1 1/4	353
FPT-210VC	90.0	35.0	24	56	1 1/4	382

PRICING: ASME MODELS

Model Number	Part No. / List Price (USD)
175 PSI	
FPT-5C	390522 / \$2,897
FPT-12C	390660 / \$3,743
FPT-20VC	390781 / \$5,009
FPT-30VC	390855 / \$5,748
FPT-42VC	390965 / \$7,375
FPT-60VC	391259 / \$10,272
FPT-70VC	391260 / \$13,978
FPT-80VC	391345 / \$15,086
FPT-120VC	391346 / \$15,939
FPT-180VC	391450 / \$16,793
FPT-210VC	391451 / \$20,082

Seismic Restraints (R); Sight Glass (SG) Available on Models FPT-20VC through FPT-210VC
 Operating Temperature Range: -20° F to 200° F

SPT MODELS: SURGE-TROL® SPRINKLER SYSTEM SURGE SUPPRESSORS, 275 PSI, ASME

F

TECHNICAL DATA

Model Number	Volume (Gal)	A Diameter (In)	B Height (In)	Sys. Conn. (In)	Shipping Weight (Lbs)
SPT-1	10	16	31	2	200
SPT-3	25	16	49	3	273
SPT-7	53	24	49	4	390
SPT-11	80	24	63	4	505
SPT-14	106	24	77	4	618
SPT-18	132	24	91	4	731
SPT-21	158	30	75	4	950
SPT-28	211	30	93	4	1,125
SPT-35	264	36	85	6	1,520
SPT-42	317	36	97	6	1,720
SPT-50	370	36	110	6	1,900
SPT-56	422	48	86	8	2,300
SPT-70	528	48	100	8	2,700

PRICING: ASME MODELS

Model Number	Part No. / List Price (USD)	Model Number	Part No. / List Price (USD)
275 PSI			
SPT-1	392871 / \$22,327	SPT-35	392866 / \$68,373
SPT-3	392872 / \$31,182	SPT-42	392867 / \$72,358
SPT-7	392844 / \$33,839	SPT-50	392868 / \$76,406
SPT-11	392849 / \$34,092	SPT-56	407356 / \$88,424
SPT-14	392857 / \$34,946	SPT-70	392870 / \$92,788
SPT-18	392862 / \$35,357		
SPT-21	392864 / \$47,849		
SPT-28	392865 / \$52,940		

Seismic Restraints (R) Standard; Sight Glass (SG) Available on Models SPT-1 through SPT-28
 Maximum Operating Temperature: 240° F

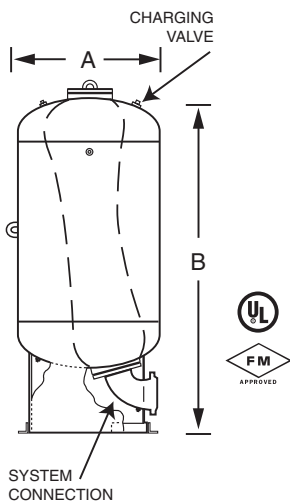
SPT-1 THROUGH SPT-70

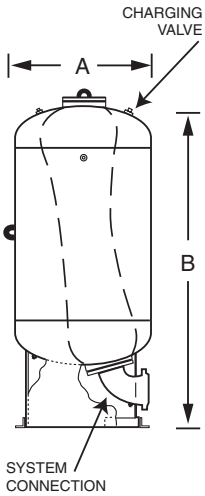

D-7 THROUGH D-70

For Water Hammer Reduction in Potable Cold or Hot Water Systems.



TECHNICAL DATA

Model Number	Volume (Gal)	A Diameter (In)	B Height (In)	Sys. Conn. (In)	Shipping Weight (Lbs)
D-7	53	24	49	4	390
D-11	80	24	63	4	505
D-14	106	24	77	4	618
D-18	132	24	91	4	731
D-21	158	30	75	4	950
D-28	211	30	93	4	1,125
D-35	264	36	85	6	1,520
D-42	317	36	97	6	1,720
D-50	370	36	110	6	1,900
D-56	422	48	86	8	2,300
D-70	528	48	100	8	2,700

PRICING: ASME MODELS

Model Number	Part No. / List Price (USD) 250 PSI
D-7	392166 / \$23,339
D-11	392164 / \$23,656
D-14	392168 / \$24,320
D-18	392167 / \$24,953
D-21	184-52 / \$37,856
D-28	417010 / \$42,125
D-35	409864 / \$58,918
D-42	392429 / \$63,124
D-50	409072 / \$67,361
D-56	187-53 / \$79,948
D-70	400947 / \$84,249

Seismic Restraints (R) Standard & Sight Glass (SG) Optional
Maximum Operating Temperature: 200° F

Additional Options: Add to Base Model List Price
Sight Glass (SG): \$482

Standard Leadtime: FPT Models: 30 Days
SPT-1 through SPT-28: 40 Days
SPT-35 through SPT-70: 60 Days
D Models: 60 Days

Connection: 250 PSI: 150# Flange; 275 PSI: 300# Flange
Warranty: 1-Year Limited

EXTROL® REPLACEMENT BLADDERS

Model Number	Part No.	Application	Shipping Weight (Lbs)	Standard Lead Time	List Price (USD)
191-3	392694	200-L	15	10 days	\$3,414
192-3	392750	300-L	20	10 days	\$3,605
193-3	392775	400-L	25	10 days	\$3,784
194-3	392803	500-L	30	10 days	\$3,909
174-16	391796	600-L	33	10 days	\$4,045
175-15	391827	800-L	35	10 days	\$4,177
176-15	391853	1000-L	37	10 days	\$5,134
177-15	391872	1200-L	43	10 days	\$5,323
178-15	391887	1400-L	52	10 days	\$5,935
179-15	391912	1600-L	55	10 days	\$6,222
180-15	391967	2000-L	63	10 days	\$6,338
180-35	391978	2500-L	71	10 days	\$6,793
180-36	391979	3000-L	82	10 days	\$7,944
180-37	391980	3500-L	102	10 days	\$10,828
180-38	391981	4000-L	109	10 days	\$13,346
180-48	391990	5000-L	128	10 days	\$15,749
180-90	392013	7500-L	155	40 days	\$17,552
180-91	417843	10000-L	225	40 days	\$24,004
180-92	392015	15000-L	310	40 days	\$39,943
10-0001	389674	35-100LBC	13	10 days	\$1,469
10-0002	389675	130-300LBC	19	10 days	\$1,988
10-0003	389676	400-600LBC	33	10 days	\$2,813

THERM-X-TROL® & WELL-X-TROL® REPLACEMENT BLADDERS

Model Number	Part No.	Application	Shipping Weight (Lbs)	Standard Lead Time	List Price (USD)
183-10	392100	WX & ST-447	16	10 days	\$3,916
183-11	392115	WX & ST 448	21	10 days	\$4,038
183-12	392124	WX & ST-449	26	10 days	\$4,124
183-13	392134	WX & ST-450	31	10 days	\$4,140
184-27	392304	WX & ST-451/421	26	10 days	\$4,299
185-22	392357	WX & ST-452/422	32	10 days	\$4,441
186-23	392415	WX & ST-453/423	37	10 days	\$5,633
181-21	392027	WX & ST-454/424	42	10 days	\$5,699
182-21	392051	WX & ST-455	48	10 days	\$6,401
187-21	392492	WX & ST-456/426	52	10 days	\$6,578
188-21	392544	WX & ST-457/427	62	10 days	\$6,806
188-80	432137	WX458	71	40 days	\$8,640
188-81	392572	WX459	82	40 days	\$9,083
188-82	392573	WX460	102	40 days	\$12,220
188-83	392574	WX461	109	40 days	\$13,125
188-84	410451	WX462	128	40 days	\$15,054
188-85		WX463	150	40 days	\$20,968
10-0004	424893	ST35-100CL	13	10 days	\$4,561
10-0005	421552	ST130-300CL	19	10 days	\$6,024
10-0006	389679	ST400-600CL	33	10 days	\$7,173
10-0007	432667	WX35-100CL	13	10 days	\$4,561
10-0008		WX130-300CL	19	10 days	\$6,024
10-0009	389682	WX400-600CL	33	10 days	\$7,173



DIATROL® & SURGE-TROL® REPLACEMENT BLADDERS

Model Number	Part No.	Application	Shipping Weight (Lbs)	Standard Leadtime	List Price (USD)
217-0039		SPT-1	10	10 days	\$3,284
217-0040	432124	SPT-3	12	10 days	\$3,390
183-77	392206	D & SPT-7	15	10 days	\$3,619
183-72	392201	D & SPT-11	20	10 days	\$3,820
183-73	392202	D & SPT-14	25	10 days	\$4,012
183-74	392203	D & SPT-18	30	10 days	\$4,140
183-75	422121	D & SPT-21	33	40 days	\$4,299
183-76	420452	D & SPT-28	35	40 days	\$4,441
181-56		D & SPT-35	37	40 days	\$5,633
181-57		D & SPT-42	43	40 days	\$5,699
181-58	438411	D & SPT-50	52	40 days	\$6,401
187-59		D & SPT-56	55	40 days	\$6,578
187-60	392504	D & SPT-70	63	40 days	\$7,097



Warranty: 1-Year Limited



Index

1-ASL.....	20	175-15.....	34	443-1.....	13	2500-L.....	18
2 1/2-AS.....	21	176-15.....	34	444-1.....	13	3000-L.....	18
2 1/2-ASL.....	20	177-15.....	34	445-1.....	13	3500-L.....	18
2-ADS.....	22	178-15.....	34	446-1.....	13	4000-L.....	18
2-AS.....	21	179-15.....	34	447-1.....	13	5000-L.....	18
2-ASL.....	20	180-15.....	34	448-1.....	13	7500-L.....	18
3-ADS.....	22	180-35.....	34	449.....	22	10000-L.....	18
3-AS.....	21	180-36.....	34	461.....	22	15000-L.....	18
3-ASL.....	20	180-37.....	34	462.....	22	390457.....	8
4-ADS.....	22	180-38.....	34	463.....	22	391218.....	8
4-AS.....	21	180-48.....	34	464.....	22	392922.....	14
4-ASL.....	20	180-90.....	34	465.....	22	392923.....	14
5-ADS.....	22	180-91.....	34	466.....	22	393038.....	14
5-AS.....	21	180-92.....	34	467.....	22	393039.....	14
5-ASL.....	20	181-21.....	34	468.....	22	393040.....	14
6-ADS.....	22	181-56.....	34	500-L.....	18	393053.....	14
6-AS.....	21	181-57.....	34	500-LBC.....	19	393070.....	14
6-ASL.....	20	181-58.....	34	537-1.....	10	393107.....	14
8-ADS.....	22	182-21.....	34	541-1.....	10	393168.....	14
8-AS.....	21	183-10.....	34	600-L.....	18	393169.....	14
8-ASL.....	20	183-11.....	34	600-LBC.....	19	393199.....	14
10-0001.....	34	183-12.....	34	601-1.....	11	393200.....	14
10-0002.....	34	183-13.....	34	601-2.....	11	393232.....	14
10-0003.....	34	183-72.....	34	601-3.....	11	393281.....	14
10-0004.....	34	183-73.....	34	601-4.....	11	393290.....	14
10-0005.....	34	183-74.....	34	603-1.....	11	393314.....	14
10-0006.....	34	183-75.....	34	603-2.....	11	393332.....	14
10-0007.....	34	183-76.....	34	603-3.....	11	393381.....	14
10-0008.....	34	183-77.....	34	603-4.....	11	393448.....	14
10-0009.....	34	184-27.....	34	603-5.....	11	393465.....	14
10-ADS.....	22	185-22.....	34	603-6.....	11	393513.....	14
10-AS.....	21	186-23.....	34	604-1.....	11	393514.....	14
10-ASL.....	20	187-21.....	34	604-2.....	11	393557.....	14
12-ADS.....	22	187-59.....	34	604-3.....	11	393571.....	14
12-AS.....	21	187-60.....	34	606-2.....	11	393572.....	14
12-ASL.....	20	188-21.....	34	606-3.....	11	396411.....	14
14-AS.....	21	188-80.....	34	606-4.....	11	396413.....	14
14-ASL.....	20	188-81.....	34	608-4.....	11	397530.....	8
16-AS.....	21	188-82.....	34	608-6.....	11	398096.....	8
16-ASL.....	20	188-83.....	34	608-7.....	11	398987.....	8
18-AS.....	21	188-84.....	34	700-C.....	13	399930.....	14
18-ASL.....	20	188-85.....	34	700-QC.....	13	426113.....	14
20-AS.....	21	191-3.....	34	701-C.....	13	427221.....	22
20-ASL.....	20	192-3.....	34	747.....	23	427222.....	22
22-AS.....	21	193-3.....	34	800-L.....	18	431262.....	14
22-ASL.....	20	194-3.....	34	1000-L.....	18	437409.....	8
24-AS.....	21	200-L.....	18	1200-L.....	18	AC12-15.....	23
24-ASL.....	20	200-LBC.....	19	1400-L.....	18	AC12-24.....	23
35-LBC.....	19	217-0039.....	34	1600-L.....	18	AC14-30.....	23
50-LBC.....	19	217-0040.....	34	2000-L.....	18	AC14-40.....	23
85-LBC.....	19	245-59.....	9	2201N002.....	9	AC16-60.....	23
100-LBC.....	19	245-60.....	9	2201N003.....	9	AC20-80.....	23
113-3.....	9	245-61.....	9	2201N006.....	9	AC20-100.....	23
130-LBC.....	19	300-L.....	18	2201N010.....	9	AC24-120.....	23
140-470.....	13	300-LBC.....	19	2201N020.....	9	AC24-135.....	23
146-832.....	9	400-L.....	18	2201N021.....	9	AC30-175.....	23
165-LBC.....	19	400-LBC.....	19	2201N022.....	9	AC30-220.....	23
174-16.....	34	420-1.....	13	2201R28.....	9	AC30-240.....	23
		420-6.....	13	2201R37.....	9	AC30-305.....	23
		421-1.....	13	2201R39.....	9	AC36-400.....	23

AC36-505.....	23	CWBT120-4.....	24	FT-110-125.....	13	SPT-7.....	32
AX-10-DD.....	16	CWBT120-6.....	24	FT-111.....	12	SPT-11.....	32
AX-15.....	16	CWBT200-3.....	24	FT-111-125.....	13	SPT-14.....	32
AX-15-DD.....	16	CWBT200-4.....	24	FT-112.....	12	SPT-18.....	32
AX-15V.....	17	CWBT200-6.....	24	HM-41L.....	14	SPT-21.....	32
AX-15V-DD.....	17	CWBT300-4.....	24	HM-41LDW.....	14	SPT-28.....	32
AX-20.....	16	CWBT300-6.....	24	HM-41Z.....	14	SPT-35.....	32
AX-20-DD.....	16	CWBT300-8.....	24	HM-41ZDW.....	14	SPT-42.....	32
AX-20V.....	17	CWBT500-6.....	24	HM-80L.....	14	SPT-50.....	32
AX-20V-DD.....	17	CWBT500-8.....	24	HM-80LDW.....	14	SPT-56.....	32
AX-40.....	16	CWBT500-10.....	24	HM-80Z.....	14	SPT-70.....	32
AX-40-DD.....	16	CWBT850-6.....	24	HM-80ZDW.....	14	ST-1.....	10
AX-40V.....	17	CWBT850-8.....	24	HWBT120-2.....	25	ST-5.....	10
AX-40V-DD.....	17	CWBT850-10.....	24	HWBT120-2/2.....	25	ST-5C.....	26
AX-60.....	16	CWBT1040-8.....	24	HWBT120-2/3.....	25	ST-5C-DD.....	26
AX-60V.....	17	CWBT1040-10.....	24	HWBT120-3.....	25	ST-12.....	10
AX-80.....	16	CWBT1040-12.....	24	HWBT120-3/3.....	25	ST-12C.....	26
AX-80V.....	17	D-7.....	33	HWBT120-4/4.....	25	ST-12C-DD.....	26
AX-100.....	16	D-11.....	33	HWBT200-2.....	25	ST-20VC.....	26
AX-100V.....	17	D-14.....	33	HWBT200-2/2.....	25	ST-20VC-DD.....	26
AX-120.....	16	D-18.....	33	HWBT200-2/3.....	25	ST-25V.....	10
AX-120V.....	17	D-21.....	33	HWBT200-3.....	25	ST-30V.....	10
AX-144.....	16	D-28.....	33	HWBT200-3/3.....	25	ST-30VC.....	26
AX-144V.....	17	D-35.....	33	HWBT200-4/4.....	25	ST-30VC-DD.....	26
AX-180.....	16	D-42.....	33	HWBT300-2.....	25	ST-35LCL.....	28
AX-180V.....	17	D-50.....	33	HWBT300-2/2.....	25	ST-42V.....	10
AX-200.....	16	D-56.....	33	HWBT300-2/3.....	25	ST-42VC.....	26
AX-200V.....	17	D-70.....	33	HWBT300-3.....	25	ST-42VC-DD.....	26
AX-240.....	16	DC-80DW.....	15	HWBT300-3/3.....	25	ST-50LCL.....	28
AX-240V.....	17	DC-120DW.....	15	HWBT300-4/4.....	25	ST-60V.....	10
AX-260.....	16	EX-15.....	12	PL-14.....	7	ST-60VC.....	26
AX-260V.....	17	EX-15PRO.....	12	PL-20.....	7	ST-70VC.....	26
AX-280.....	16	EX-30.....	12	PL-26.....	7	ST-80V.....	10
AX-280V.....	17	EX-30PRO.....	12	PL-32.....	7	ST-80VC.....	26
CH-14.....	6	EX-60.....	12	PL-34.....	7	ST-85LCL.....	28
CH-20.....	6	EX-60PRO.....	12	PL-44.....	7	ST-100LCL.....	28
CH-26.....	6	EX-90.....	12	PL-62.....	7	ST-120VC.....	26
CH-32.....	6	EX-1500-100.....	12	PL-81.....	7	ST-130LCL.....	28
CH-34.....	6	EX-1500-125.....	12	PL-86.....	7	ST-165LCL.....	28
CH-41Z-B.....	14	EX-3000-100.....	12	PL-119.....	7	ST-180V.....	10
CH-41ZCT-B.....	14	EX-3000-125.....	12	Repair Kit.....	23	ST-180VC.....	26
CH-41ZCT-G.....	14	FPT-5C.....	32	RO-4.....	7	ST-200LCL.....	28
CH-41ZCT-R.....	14	FPT-12C.....	32	RO-10.....	7	ST-200V.....	10
CH-41ZDW-B.....	14	FPT-20VC.....	32	RO-14.....	7	ST-210V.....	10
CH-41ZDW-G.....	14	FPT-30VC.....	32	RO-20.....	7	ST-210VC.....	26
CH-41ZDW-R.....	14	FPT-42VC.....	32	RO-20PA.....	7	ST-300LCL.....	28
CH-41Z-G.....	14	FPT-60VC.....	32	RO-34.....	7	ST-400LCL.....	28
CH-41Z-R.....	14	FPT-70VC.....	32	RO-34PA.....	7	ST-447C.....	27
CH-44.....	6	FPT-80VC.....	32	RO-44.....	7	ST-448C.....	27
CH-62.....	6	FPT-120VC.....	32	RO-44PA.....	7	ST-449C.....	27
CH-80Z-B.....	14	FPT-180VC.....	32	RO-86.....	7	ST-450C.....	27
CH-80ZDW-B.....	14	FPT-210VC.....	32	RO-86PA.....	7	ST-451C.....	27
CH-80ZDW-G.....	14	FT-15.....	12	RO-119PA.....	7	ST-452C.....	27
CH-80ZDW-R.....	14	FT-30.....	12	RP-10HP.....	9	ST-453C.....	27
CH-80Z-G.....	14	FT-109.....	12	RP-15HP.....	9	ST-454C.....	27
CH-80Z-R.....	14	FT-109-15.....	12	RP-25HP.....	9	ST-455C.....	27
CH-81.....	6	FT-109-100.....	13	S-80.....	15	ST-456C.....	27
CH-86.....	6	FT-109-125.....	13	S-120.....	15	ST-457C.....	27
CH-119.....	6	FT-110.....	12	SPT-1.....	32	ST-500LCL.....	28
CWBT120-3.....	24	FT-110-100.....	13	SPT-3.....	32	ST-600LCL.....	28



SX-30V.....	12	WX-201	4	WX-251PA	4
SX-40V.....	12	WX-201D	5	WX-251PA-G.....	4
SX-60V.....	12	WX-201D-G	5	WX-251PA-T.....	4
SX-90V.....	12	WX-201D-T.....	5	WX-251-T.....	4
SX-110V	12	WX-201-G.....	4	WX-251UG.....	6
SX-130V	12	WX-201-T.....	4	WX-255	4
SX-160V	12	WX-202	4	WX-255D.....	5
T-5	10	WX-202D.....	5	WX-255D-G.....	5
T-12.....	10	WX-202D-G.....	5	WX-255D-T.....	5
WF-14.....	6	WX-202D-T.....	5	WX-255-G.....	4
WF-20.....	6	WX-202-G.....	4	WX-255PA	4
WF-26.....	6	WX-202H.....	5	WX-255PA-G.....	4
WF-32.....	6	WX-202PA	4	WX-255PA-T.....	4
WF-34.....	6	WX-202PA-G.....	4	WX-255-T.....	4
WF-44.....	6	WX-202PA-T.....	4	WX-300LCL	31
WF-62.....	6	WX-202PS	5	WX-302	4
WF-81.....	6	WX-202-T.....	4	WX-302D	5
WF-86.....	6	WX-202UG.....	6	WX-302D-G.....	5
WF-119.....	6	WX-202XL.....	4	WX-302D-T.....	5
WH-7C.....	15	WX-202XLD.....	5	WX-302-G.....	4
WH-7CDW.....	15	WX-202XLD-G.....	5	WX-302PA	4
WH-7ZC.....	15	WX-202XLD-T.....	5	WX-302PA-G.....	4
WHS-60L.....	15	WX-202XL-G.....	4	WX-302PA-T.....	4
WHS-60LDW.....	15	WX-202XLPA	4	WX-302-T.....	4
WHS-60Z.....	15	WX-202XLPA-G.....	4	WX-350	4
WHS-60ZC.....	15	WX-202XLPA-T.....	4	WX-350D.....	5
WHS-60ZCDW	15	WX-202XL-T.....	4	WX-350D-G.....	5
WHS-60ZDW	15	WX-203	4	WX-350D-T.....	5
WHS-80L.....	15	WX-203D	5	WX-350-G.....	4
WHS-80LDW.....	15	WX-203D-G.....	5	WX-350PA.....	4
WHS-80Z.....	15	WX-203D-T.....	5	WX-350PA-G.....	4
WHS-80ZC.....	15	WX-203-G.....	4	WX-350PA-T.....	4
WHS-80ZCDW	15	WX-203PA	4	WX-350-T.....	4
WHS-80ZDW	15	WX-203PA-G.....	4	WX-400LCL.....	31
WHS-120L.....	15	WX-203PA-T.....	4	WX-401C.....	29
WHS-120Z.....	15	WX-203-T.....	4	WX-402C.....	29
WHS-120ZC.....	15	WX-205	4	WX-403C.....	29
WHS-120ZCDW	15	WX-205D.....	5	WX-404C.....	29
WX1-250D.....	6	WX-205D-G.....	5	WX-405C.....	29
WX1-251D.....	6	WX-205D-T.....	5	WX-406C.....	29
WX1-302D.....	6	WX-205-G.....	4	WX-407C.....	29
WX-35LCL.....	31	WX-205PA.....	4	WX-447C.....	30
WX-50LCL.....	31	WX-205PA-G.....	4	WX-448C.....	30
WX-85LCL.....	31	WX-205PA-T.....	4	WX-449C.....	30
WX-100LCL.....	31	WX-205-T.....	4	WX-450C.....	30
WX-101.....	5	WX-250	4	WX-451C.....	30
WX-101C-DD.....	29	WX-250D.....	5	WX-452C.....	30
WX-102.....	5	WX-250D-G.....	5	WX-453C.....	30
WX-102C-DD.....	29	WX-250D-T.....	5	WX-454C.....	30
WX-102PS.....	5	WX-250-G.....	4	WX-455C.....	30
WX-103.....	5	WX-250PA.....	4	WX-456C.....	30
WX-103C-DD.....	29	WX-250PA-G.....	4	WX-457C.....	30
WX-104.....	5	WX-250PA-T.....	4	WX-458C.....	30
WX-110PS.....	5	WX-250-T.....	4	WX-459C.....	30
WX-130LCL.....	31	WX-250UG.....	6	WX-460C.....	30
WX-165LCL.....	31	WX-251	4	WX-461C.....	30
WX-200.....	5	WX-251D.....	5	WX-462C.....	30
WX-200LCL.....	31	WX-251D-G.....	5	WX-463C.....	30
WX-200PS.....	5	WX-251D-T.....	5	WX-500LCL.....	31
WX-200UG.....	6	WX-251-G.....	4	WX-600LCL.....	31

Commercial Part Number Cross Reference Chart

Prior PART NO PART NO

**AX MODELS: HORIZONTAL DIAPHRAGM
TYPE, (ASME) 125 PSI W/OUT SADDLES**

117-0015	389849
117-0020	389852
117-0040	389857
117-0060	389860
117-80	390178
117-100	389895
117-120	389926
117-144	389932
117-180	389938
117-200	389944
117-408	389967
117-420	389974
117-430	389978

**AX MODELS: HORIZONTAL DIAPHRAGM
TYPE, (ASME) 150 PSI W/OUT SADDLES**

117-459	390001
117-462	390004
117-465	390007
117-468	390010
117-525	N / A
117-476	N / A
117-481	390020
117-484	N / A
117-487	390024
117-490	390027
117-493	390030
117-496	N / A
117-499	N / A

**AX MODELS: HORIZONTAL DIAPHRAGM
TYPE, (ASME) 175 PSI W/OUT SADDLES**

117-556	N / A
117-554	N / A
117-553	N / A
117-449	389995
117-638	390147

**AX MODELS: HORIZONTAL DIAPHRAGM
TYPE, (ASME) 250 PSI W/OUT SADDLES**

117-622	390134
---------	--------

**AX-V MODELS: VERTICAL DIAPHRAGM
TYPE, (ASME) 125 PSI**

117-401	389959
117-402	389960
117-403	389961
117-0062	389861
117-81	390179
117-101	389900
117-121	389927
117-145	389933
117-181	389939
117-201	389945
117-281	389955
117-421	389975
117-431	389979

**AX-V MODELS: VERTICAL DIAPHRAGM
TYPE, (ASME) 150 PSI**

117-461	390003
117-464	390006
117-467	390009
117-470	390012
117-474	390016
117-479	390019
117-483	390021
117-486	390023
117-489	390026
117-492	390029
117-495	390031
117-498	390034
117-501	390037

**AX-V MODELS: VERTICAL DIAPHRAGM
TYPE, (ASME) 175 PSI**

117-454	389999
117-452	389997
117-453	389998
117-0559	389869
117-588	390109
117-620	390133
117-565	390091
117-585	400764
117-580	390101

**AX-V MODELS: VERTICAL DIAPHRAGM
TYPE, (ASME) 250 PSI**

117-551	390081
117-573	390097
117-637	390146
117-591	390112
117-569	N / A
117-558	N / A
117-593	N / A
117-102	389905
117-557	N / A

**AX-V MODELS: VERTICAL DIAPHRAGM
TYPE, (ASME) 300 PSI**

117-572	N / A
117-586	390107
117-625	390137
117-550	390080
117-589	390110
117-598	N / A

**L MODELS: FULL ACCEPTANCE BLADDER,
TOP CONNECTION, (ASME) 125 PSI**

191-2	392691
192-2	392746
193-2	392772
194-2	392800
174-2	391797
175-2	391828
176-2	391854
177-2	391874
178-2	391888
179-2	391913

L MODELS: 125 PSI (continued)

180-2	391969
180-33	391976
180-34	391977
189-1	392643
189-2	392646
189-3	392651
189-24	392649
180-137	N / A
189-10	392644

**L MODELS: FULL ACCEPTANCE BLADDER,
TOP CONNECTION, (ASME) 150 PSI**

117-509	390045
117-510	390046
117-511	390047
117-512	390048
117-513	390049
117-514	390050
117-515	390051
117-516	390052
117-517	390053
117-518	390054
117-519	390055
117-520	390056
117-521	390057
117-522	390058
117-523	400946
117-940	N / A
117-473	390015
117-941	N / A
117-475	N / A

**L MODELS: FULL ACCEPTANCE BLADDER,
TOP CONNECTION, (ASME) 175 PSI**

191-19	392690
192-20	392747
193-20	392773
194-19	392799
174-22	N / A
175-22	391829
176-22	391855
177-22	N / A
178-22	391889
179-22	N / A
180-22	391970
180-40	N / A
180-39	N / A
180-41	N / A
180-42	N / A
180-65	391997
180-55	N / A
180-57	N / A
180-59	391995



Commercial Part Number Cross Reference Chart

L MODELS: FULL ACCEPTANCE BLADDER, TOP CONNECTION, (ASME) 250 PSI

191-18.....	392689
192-19.....	N / A
193-19.....	408366
194-18.....	408367
174-23.....	N / A
175-23.....	391830
176-23.....	N / A
177-16.....	391873
178-23.....	391890
179-23.....	391915
180-23.....	N / A
180-43.....	391985
180-44.....	391986
180-45.....	391987
180-46.....	N / A
189-7.....	N / A
189-42.....	392660
180-58.....	N / A
180-60.....	N / A

L MODELS: FULL ACCEPTANCE BLADDER, TOP CONNECTION, (ASME) 300 PSI

191-42.....	N / A
192-39.....	392759
193-41.....	N / A
194-37.....	N / A
194-39.....	N / A
175-37.....	391834
176-35.....	N / A
177-33.....	N / A
178-34.....	N / A
179-34.....	N / A
180-74.....	392004
180-76.....	N / A
180-64.....	N / A
180-78.....	N / A
180-79.....	N / A
180-129.....	N / A
180-81.....	392007
180-82.....	392008
180-83.....	N / A

LBC MODELS: PARTIAL ACCEPTANCE BLADDER, BOTTOM CONNECTION, (ASME) 125 PSI

165-5.....	391655
166-5.....	391685
167-4.....	391715
168-4.....	391732
169-4.....	391746
171-15.....	391760
191-33.....	392697
192-31.....	392752
193-32.....	392778
194-32.....	392804
174-36.....	391802

LBC MODELS: PARTIAL ACCEPTANCE BLADDER, BOTTOM CONNECTION, (ASME) 150 PSI

165-10.....	391645
166-10.....	391675
167-10.....	391705
168-10.....	391728
117-502.....	390038
117-503.....	390039
117-504.....	390040
117-505.....	401106
117-506.....	390042
117-507.....	390043
117-508.....	390044

LBC MODELS: PARTIAL ACCEPTANCE BLADDER, BOTTOM CONNECTION, (ASME) 175 PSI

117-601.....	390120
117-103.....	N / A

LBC MODELS: PARTIAL ACCEPTANCE BLADDER, BOTTOM CONNECTION, (ASME) 250 PSI

166-18.....	391682
-------------	--------

LBC MODELS: PARTIAL ACCEPTANCE BLADDER, BOTTOM CONNECTION, (ASME) 300 PSI

166-1.....	N / A
167-18.....	N / A

TANGENTIAL AIR SEPARATORS LESS STRAINER (ASME) 125 PSI

489-1.....	394020
490-6.....	394035
491-6.....	394051
492F0006.....	394083
493-0006.....	394087
494-0006.....	394113
495-6.....	394155
496-6.....	394186
497-6.....	394212
498-6.....	394244
499-6.....	394315
499-24.....	394288
499-15.....	400789
499-27.....	394290
499-55.....	N / A
499-19.....	394287

TANGENTIAL AIR SEPARATORS LESS STRAINER (ASME) 150 PSI

489-5.....	394022
490-26.....	394032
491-15.....	394046
492-27.....	394071
493-29.....	394106
494-23.....	394126
495-28.....	394149
496-26.....	394176
497-18.....	394201
498-19.....	394238
499-46.....	394308
499-47.....	394309
499-48.....	394310
499-49.....	N / A
499-31.....	N / A
499-50.....	N / A

TANGENTIAL AIR SEPARATORS LESS STRAINER (ASME) 175 PSI

492-31.....	394075
493-33.....	N / A
494-21.....	394124
495-21.....	N / A
496-18.....	394170
497-27.....	N / A

TANGENTIAL AIR SEPARATORS LESS STRAINER (ASME) 250 PSI

490-28.....	394034
491-18.....	394049
492-32.....	N / A
493-10.....	394100
494-17.....	N / A
495-17.....	N / A
496-14.....	394169
497-28.....	N / A
191-40.....	392704
499-66.....	N / A

TANGENTIAL AIR SEPARATORS LESS STRAINER (ASME) 300 PSI

491-16.....	N / A
492-28.....	N / A
493-31.....	394108
496-29.....	394178
497-21.....	N / A
191-38.....	392702
502-4.....	394389

Commercial Part Number Cross Reference Chart

TANGENTIAL AIR SEPARATORS WITH STRAINER (ASME) 125 PSI

490-7.....	398301
491-7.....	394052
492F0007.....	394084
493-0007.....	394088
494-0007.....	394114
495-7.....	394156
496-7.....	394187
497-7.....	394213
498-7.....	394245
499-7.....	394320
499-10.....	394282
499-33.....	394296
499-29.....	N / A
499-35.....	N / A
499-40.....	N / A

TANGENTIAL AIR SEPARATORS WITH STRAINER (ASME) 150 PSI

490-25.....	394031
491-14.....	394045
492-26.....	394070
493-28.....	394105
494-22.....	394125
495-27.....	394148
496-25.....	394175
497-17.....	394200
498-18.....	394237
499-41.....	394303
499-42.....	394304
499-43.....	394305
499-44.....	394306
499-54.....	N / A
499-45.....	N / A

TANGENTIAL AIR SEPARATORS WITH STRAINER (ASME) 175 PSI

490-27.....	N / A
491-17.....	N / A
492-30.....	394074
493-32.....	400948
495-20.....	394142
496-20.....	394171
497-22.....	394204
498-21.....	394240
499-69.....	N / A
499-68.....	394318
503-03.....	N / A

TANGENTIAL AIR SEPARATORS WITH STRAINER (ASME) 250 PSI

492-29.....	394073
493-30.....	N / A
495-31.....	N / A
496-10.....	N / A
497-20.....	N / A
191-44.....	N / A
499-71.....	N / A
502-2.....	N / A
503-1.....	N / A
499-70.....	N / A

TANGENTIAL AIR SEPARATORS WITH STRAINER (ASME) 300 PSI

492-33.....	N / A
494-16.....	N / A
496-36.....	N / A
497-23.....	N / A
498-23.....	N / A
499-74.....	N / A
502-1.....	N / A
499-73.....	N / A
499-72.....	N / A

AIR & DIRT SEPARATORS (ASME) 125 PSI

523-01.....	394539
523-03.....	394541
523-04.....	394542
523-05.....	394543
523-06.....	394544
523-08.....	394546
523-10.....	394548
523-20.....	N / A

AIR & DIRT SEPARATORS (ASME) 150 PSI

523-02.....	394540
523-07.....	394545
523-09.....	394547
523-11.....	394549
523-12.....	394550
523-13.....	394551
523-14.....	N / A
523-21.....	394559

INLINE AIR PURGERS

449-1.....	393997
461-1.....	393998
462-1.....	393999
463-1.....	394000
464-1.....	394001
465-1.....	394002
466-1.....	394004
467-1.....	394006
468-1.....	394009

HIGH CAPACITY AIR VENT

117-472.....	390014
117-524.....	390060

AC MODELS: PLAIN STEEL COMPRESSION TANKS, (ASME)

183-8014.....	392213
183-8015.....	392214
183-8016.....	392215
183-8017.....	392216
183-8018.....	392217
183-8019.....	392218
183-8020.....	392219
183-8021.....	392220
183-8022.....	392221
183-8023.....	392222
183-8024.....	400774
183-8025.....	N / A
183-8026.....	392225
183-8028.....	N / A
183-8029.....	392227

CWBT MODELS: CHILLED WATER BUFFER TANKS (ASME) 125 PSI

517-01.....	394402
517-02.....	394403
517-03.....	N / A
517-04.....	394405
517-05.....	394406
517-06.....	394407
517-07.....	394408
517-08.....	394409
517-09.....	N / A
517-10.....	394411
517-11.....	394422
517-12.....	N / A
517-13.....	394433
517-14.....	394434
517-15.....	394435
517-16.....	394436
517-17.....	N / A
517-18.....	N / A

CWBT MODELS: CHILLED WATER BUFFER TANKS (ASME) 150 PSI

517-28.....	394448
517-19.....	394439
517-49.....	N / A
517-38.....	394457
517-31.....	407429
517-21.....	400949
517-27.....	394447
517-34.....	394454
517-25.....	394445



Commercial Part Number Cross Reference Chart

HWBT MODELS: HOT WATER BUFFER TANKS (ASME) 125 PSI

527-101	394575
527-102	394576
527-201	394583
527-202	394584
527-301	N / A
527-302	N / A
527-103	394577
527-104	394578
527-105	394579
527-106	394580
527-203	394585
527-204	N / A
527-205	394587
527-206	394588
527-303	N / A
527-304	N / A
527-305	N / A
527-306	394600

HWBT MODELS: HOT WATER BUFFER TANKS (ASME) 150 PSI

527-209	394591
527-208	394590
527-310	394604

ST MODELS: DIAPHRAGM TYPE, (ASME) 150 PSI

140-004	390414
141-008	390602
141-009	390603
143-218	401681
144-0148	401800
146-751	391243
146-790	391251
147-139	391323
147-199	391331
148-109	391441
148-110	391442

ST MODELS: DIAPHRAGM TYPE, (ASME) 175 PSI

140-002	390413
141-007	390601
141-010	401796
146-830	391274
146-831	391275
146-804	391255
146-827	391271
147-239	391355
147-240	N / A
148-168	391457
148-169	391458

ST MODELS: DIAPHRAGM TYPE, (ASME) 250 PSI

140-751	390525
141-354	390651
142-181	390779
143-349	390847
144-245	390960
146-828	403070
146-829	391273
147-216	391337
147-241	391357
148-170	391459
148-171	391460

ST MODELS: DIAPHRAGM TYPE, (ASME) 300 PSI

140-732	390516
141-355	390652
142-186	390784
143-368	390852
146-811	N / A
146-835	401860
147-231	391347
147-232	391348

ST MODELS FULL-ACCEPTANCE REPLACEABLE BLADDER (ASME) 125 PSI

183-48	392172
183-49	392173
183-50	392174
183-51	392180
184-38	392307
185-38	392360
186-38	392418
181-38	N / A
182-38	392054
187-38	408015
188-38	392547

ST MODELS FULL-ACCEPTANCE REPLACEABLE BLADDER (ASME) 150 PSI

183-66	392195
183-67	392196
183-68	392197
183-69	392198
184-69	392324
185-60	392373
186-60	392432
181-53	392036
182-56	392060
187-58	392502
118-68	390312

ST MODELS FULL-ACCEPTANCE REPLACEABLE BLADDER (ASME) 175 PSI

183-88	392246
183-93	392247
184-73	N / A
185-39	N / A
186-39	403073
181-39	N / A

ST MODELS FULL-ACCEPTANCE REPLACEABLE BLADDER (ASME) 250 PSI

183-70	392199
183-147	401268
183-56	392185
183-134	392138
184-40	N / A
185-40	392362
187-40	N / A
188-99	N / A

ST MODELS FULL-ACCEPTANCE REPLACEABLE BLADDER (ASME) 300 PSI

183-127	N / A
183-135	392139
184-79	392333

ST-CL MODELS: PARTIAL ACCEPTANCE BLADDER (ASME) 150 PSI

165-6	391656
166-6	391686
167-5	391716
168-5	391733
169-5	391747
171-16	391761
191-34	392698
192-32	392753
193-33	392779
194-33	392805
174-38	391804

Commercial Part Number Cross Reference Chart

WX MODELS DIAPHRAGM TYPE (ASME) 125 PSI

144-80.....	390996
145-80.....	391124
146-80.....	391253
147-80.....	391378
149-80.....	391513
149-138.....	391484
149-139.....	391485

WX MODELS DIAPHRAGM TYPE (ASME) 150 PSI

144-258.....	390964
145-1000.....	391079
146-807.....	391257
147-228.....	391344
149-155.....	391492
149-156.....	391493
149-157.....	391494

WX MODELS DIAPHRAGM TYPE (ASME) 175 PSI

144-160.....	390950
145-70.....	391122
146-760.....	391245
147-129.....	391320
149-41.....	391511
149-144.....	391489
149-159.....	391496

WX MODELS DIAPHRAGM TYPE (ASME) 250 PSI

144-82.....	390997
145-95.....	391126
146-768.....	391246
147-125.....	391319
149-40.....	391510
149-160.....	391497
149-146.....	391490

WX MODELS DIAPHRAGM TYPE (ASME) 300 PSI

144-83.....	390998
145-1003.....	391081
172-01.....	391768
173-01.....	391770
173-03.....	391772
149-169.....	N / A
149-170.....	391507

WX MODELS: REPLACEABLE BLADDER (ASME) 125 PSI

183-18.....	392152
183-19.....	392153
183-17.....	392151
183-20.....	392154
184-35.....	392306
185-35.....	392359
186-35.....	392417
181-35.....	392029
182-35.....	392053
187-35.....	392494
188-35.....	392546
188-70.....	392561
188-71.....	392562
188-72.....	392563
188-73.....	392564
188-74.....	392565
188-96.....	392587

WX MODELS: REPLACEABLE BLADDER (ASME) 150 PSI

183-62.....	392191
183-63.....	392192
183-64.....	392193
183-65.....	392194
184-70.....	392325
185-61.....	392374
186-62.....	392433
181-55.....	392037
182-58.....	392061
187-56.....	392501
188-66.....	392558
188-79.....	392570
188-97.....	392588
188-91.....	N / A

WX MODELS: REPLACEABLE BLADDER (ASME) 175 PSI

183-38.....	392165
183-46.....	392170
183-23.....	407471
183-100.....	392101
184-41.....	392309
185-41.....	392363
186-41.....	392420
181-41.....	392032
182-41.....	N / A
187-41.....	N / A
188-41.....	N / A

WX MODELS: REPLACEABLE BLADDER (ASME) 250 PSI

183-25.....	392156
183-26.....	392157
183-27.....	392158
183-28.....	392159
184-42.....	392310
185-42.....	392364
186-42.....	402640
181-42.....	392033
182-42.....	N / A
187-42.....	392498
188-42.....	N / A
188-94.....	N / A

WX MODELS: REPLACEABLE BLADDER (ASME) 300 PSI

183-122.....	392126
183-116.....	392120
183-99.....	N / A
183-52.....	392181
184-74.....	392329
185-56.....	N / A
187-64.....	N / A
188-68.....	N / A

WX-CL MODELS: PARTIAL ACCEPTANCE BLADDER, (ASME) 125 PSI

165-8.....	407286
166-8.....	408763
167-7.....	N / A
168-8.....	N / A
169-8.....	408539
171-18.....	391763
191-36.....	392700
192-34.....	392755
193-35.....	392781
194-35.....	392807
174-40.....	391806

FPT MODELS: FIRE-X-TROL SPRINKLER SYSTEM EXPANSION TANKS, (ASME) 175 PSI

140-757.....	390528
140-746.....	390522
141-370.....	390660
142-183.....	390781
143-373.....	390855
144-259.....	390965
146-809.....	391259
146-810.....	391260
147-229.....	391345
147-230.....	391346
148-161.....	391450
148-162.....	391451



Commercial Part Number Cross Reference Chart

SPT MODELS: SURGE-TROL SPRINKLER SYSTEM SURGE SUPPRESSORS, 275 PSI

217-012	392871
217-013	392872
217-001	392844
217-002	392849
217-003	392857
217-004	392862
217-005	392864
217-006	392865
217-007	392866
217-008	392867
217-009	392868
217-010	407356
217-011	392870

D MODELS: DIATROL SHOCK SUPPRESSORS, 250 PSI

183-39.....	392166
183-37.....	392164
183-44.....	392168
183-42.....	392167
184-52.....	N / A
184-57.....	N / A
186-47.....	N / A
186-57.....	392429
186-56.....	409072
187-53.....	N / A
188-50.....	400947

REPLACEMENT BLADDERS ~ EXTROL

191-3.....	392694
192-3.....	392750
193-3.....	392775
194-3.....	392803
174-16.....	391796
175-15.....	391827
176-15.....	391853
177-15.....	391872
178-15.....	391887
179-15.....	391912
180-15.....	391967
180-35.....	391978
180-36.....	391979
180-37.....	391980
180-38.....	391981
180-48.....	391990
180-90.....	392013
180-91.....	N / A
180-92.....	392015
10-0001	389674
10-0002	389675
10-0003	389676

REPLACEMENT BLADDERS ~ THERM-X-TROL & WELL-X-TROL

183-10.....	392100
183-11.....	392115
183-12.....	392124
183-13.....	392134
184-27.....	392304
185-22.....	392357
186-23.....	392415
181-21.....	392027
182-21.....	392051
187-21.....	392492
188-21.....	392544
188-80.....	N / A
188-81.....	392572
188-82.....	392573
188-83.....	392574
188-84.....	N / A
188-85.....	N / A
10-0004	N / A
10-0005	N / A
10-0006	389679
10-0007	N / A
10-0008	N / A
10-0009	389682

REPLACEMENT BLADDERS ~ DIATROL & SURGE-TROL

217-0039	N / A
217-0040	N / A
183-77.....	392206
183-72.....	392201
183-73.....	392202
183-74.....	392203
183-75.....	N / A
183-76.....	N / A
181-56.....	N / A
181-57.....	N / A
181-58.....	N / A
187-59.....	N / A
187-60.....	392504

AX Models: Horizontal Diaphragm Type, ASME

Base Model	Part No.	Seismic Restraints	Part No.	Sight Glass	Part No.	Sight Glass & Restraints	Part No.
AX15-125-DD	416837	AX15-125R	389850	AX15-125SG	389853	AX15-125SGR	435543
AX20-125-DD	416839	AX20-125R	389854	AX20-125SG	414410	AX20-125SGR	420393
AX40-125-DD	416841	AX40-125R	389858	AX40-125SG	418199	AX40-125SGR	389982
AX60-125	389860	AX60-125R	389862	AX60-125SG	389863	AX60-125SGR	389864
AX80-125	390178	AX80-125R	390187	AX80-125SG	117-87	AX80-125SGR	390192
AX100-125	389895	AX100-125R	389917	AX100-125SG	117-107	AX100-125SGR	389924
AX120-125	389926	AX120-125R	389928	AX120-125SG	117-128	AX120-125SGR	117-143
AX144-125	389932	AX144-125R	389935	AX144-125SG	389936	AX144-125SGR	117-155
AX180-125	389938	AX180-125R	389940	AX180-125SG	389941	AX180-125SGR	117-190
AX200-125	389944	AX200-125R	389946	AX200-125SG	418367	AX200-125SGR	409121
AX240-125	389967	AX240-125R	389968	AX240-125SG	117-411	AX240-125SGR	N/A
AX260-125	389974	AX260-125R	389976	AX260-125SG	117-423	AX260-125SGR	117-617
AX280-125	389978	AX280-125R	389980	AX280-125SG	117-433	AX280-125SGR	N/A

AX-V Models: Vertical Diaphragm Type, ASME

Base Model	Part No.	Seismic Restraints	Part No.	Sight Glass	Part No.	Sight Glass & Restraints	Part No.
AX15V-125-DD	416838	AX15V-125R-DD	421890	AX15V-125SG	389966	AX15V-125SGR-DD	422296
AX20V-125-DD	416840	AX20V-125R-DD	421891	AX20V-125SG	389965	AX20V-125SGR-DD	421568
AX40V-125-DD	416842	AX40V-125R-DD	421892	AX40V-125SG-DD	432926	AX40V-125SGR-DD	422298
AX60V-125	389861	AX60V-125R	389957	AX60V-125SG	389865	AX60V-125SGR	390100
AX80V-125	390179	AX80V-125R	389953	AX80V-125SG	390202	AX80V-125SGR	389954
AX100V-125	389900	AX100V-125R	390184	AX100V-125SG	389925	AX100V-125SGR	390223
AX120V-125	389927	AX120V-125R	389956	AX120V-125SG	389930	AX120V-150SGR	390089
AX144V-125	389933	AX144V-125R	408709	AX144V-125SG	389934	AX144V-125SGR	N/A
AX180V-125	389939	AX180V-125R	389963	AX180V-125SG	389943	AX180V-125SGR	390125
AX200V-125	389945	AX200V-125R	389958	AX200V-125SG	389948	AX200V-125SGR	390090
AX240V-125	389955	AX240V-125R	390194	AX240V-125SG	389970	AX240V-125SGR	419046
AX260V-125	389975	AX260V-125R	389986	AX260V-125SG	117-442	AX260V-125SGR	390098
AX280V-125	389979	AX280V-125R	389987	AX280V-125SG	117-437	AX280V-125SGR	117-577

L Models: Full Acceptance Bladder, Top Connection, ASME

Base Model	Part No.	Seismic Restraints	Part No.	Sight Glass	Part No.	Sight Glass & Restraints	Part No.
200L-125	392691	200L-125R	392712	200L-125SG	392688	200L-125SGR	392713
300L-125	392746	300L-125R	392749	300L-125SG	392744	300L-125SGR	392751
400L-125	392772	400L-125R	392776	400L-125SG	392770	400L-125SGR	392788
500L-125	392800	500L-125R	392814	500L-125SG	392797	500L-125SGR	392813
600L-125	391797	600L-125R	391801	600L-125SG	391811	600L-125SGR	407496
800L-125	391828	800L-125R	391832	800L-125SG	391839	800L-125SGR	391833
1000L-125	391854	1000L-125R	391858	1000L-125SG	391864	1000L-125SGR	391861
1200L-125	391874	1200L-125R	391878	1200L-125SG	420333	1200L-125SGR	177-24
1400L-125	391888	1400L-125R	391892	1400L-125SG	178-8	1400L-125SGR	391894
1600L-125	391913	1600L-125R	391916	1600L-125SG	179-7	1600L-125SGR	391918
2000L-125	391969	2000L-125R	410883	2000L-125SG	180-7	2000L-125SGR	391968
2500L-125	391976	2500L-125R	180-47	2500L-125SG	N/A	2500L-125SGR	391963
3000L-125	391977	3000L-125R	180-54	3000L-125SG	392011	3000L-125SGR	180-132
3500L-125	392643	3500L-125R	417201	3500L-125SG	392645	3500L-125SGR	392661
4000L-125	392646	4000L-125R	392650	4000L-125SG	189-36	4000L-125SGR	418312
5000L-125	392651	5000L-125R	N/A	5000L-125SG	N/A	5000L-125SGR	392659

FREQUENTLY USED PART NUMBERS

LBC Models: Partial Acceptance Bladder, Bottom Connection, ASME

Base Model	Part No.	Seismic Restraints	Part No.	Sight Glass	Part No.	Sight Glass & Restraints	Part No.
35LBC-125	391655	35LBC-125R	391647	35LBC-125SG	391646	35LBC-125SGR	391649
50LBC-125	391685	50LBC-125R	391677	50LBC-125SG	166-11	50LBC-125SGR	391679
85LBC-125	391715	85LBC-125R	391706	85LBC-125SG	N/A	85LBC-125SGR	391707
100LBC-125	391732	100LBC-125R	391735	100LBC-125SG	391729	100LBC-125SGR	N/A
130LBC-125	391746	130LBC-125R	391749	130LBC-125SG	408762	130LBC-125SGR	400773
165LBC-125	391760	165LBC-125R	417983	165LBC-125SG	N/A	165LBC-125SGR	417618
200LBC-125	392697	200LBC-125R	392705	200LBC-125SG	191-39	200LBC-125SGR	191-45
300LBC-125	392752	300LBC-125R	192-37	300LBC-125SG	392758	300LBC-125SGR	N/A
400LBC-125	392778	400LBC-125R	392783	400LBC-125SG	193-40	400LBC-125SGR	392791
500LBC-125	392804	500LBC-125R	N/A	500LBC-125SG	N/A	500LBC-125SGR	392811
600LBC-125	391802	600LBC-125R	174-42	600LBC-125SG	N/A	600LBC-125SGR	N/A

ST Models: Diaphragm Type, ASME

Base Model	Part No.	Seismic Restraints	Part No.	Sight Glass	Part No.	Sight Glass & Restraints	Part No.
ST20VC-150-DD	390603	ST20VC-150R-DD	418363	ST20VC-150SG-DD	429416	ST20VC-150SGR-DD	421679
ST30VC-150-DD	401681	ST30VC-150R-DD	418364	ST30VC-150SG-DD	423314	ST30VC-150SGR-DD	424871
ST42VC-150-DD	401800	ST42VC-150R-DD	418366	ST42VC-150SG-DD	422453	ST42VC-150SGR	N/A
ST60VC-150	391243	ST60VC-150R	391252	ST60VC-150SG	410768	ST60VC-150SGR	410427
ST70VC-150	391251	ST70VC-150R	391268	ST70VC-150SG	411849	ST70VC-150SGR	391714
ST80VC-150	391323	ST80VC-150R	391332	ST80VC-150SG	391324	ST80VC-150SGR	391330
ST120VC-150	391331	ST120VC-150R	391339	ST120VC-150SG	413064	ST120VC-150SGR	391369
ST180VC-150	391441	ST180VC-150R	391447	ST180VC-150SG	148-120	ST180VC-150SGR	419331
ST210VC-150	391442	ST210VC-150R	148-166	ST210VC-150SG	148-116	ST210VC-150SGR	N/A

Well-X-Trol® ESP Quick Sizing Table

Pump Discharge Rate (Approx. GPM)	Pumps Up To 3/4 hp & 1 Minute Run Time			Pumps Over 3/4 hp & 2 Minute Run Time		
	30/50 psig	40/60 psig	50/70 psig	30/50 psig	40/60 psig	50/70 psig
5	WX-202	WX-202	WX-202XL	WX-205	WX-250	WX-250
7	WX-202XL	WX-203	WX-203	WX-251	WX-251	WX-251
10	WX-203	WX-250	WX-250	WX-255	WX-255	WX-302
12	WX-250	WX-251	WX-251	WX-255	WX-350	WX-350
15	WX-251	WX-251	WX-255	WX-350	WX-350	WX-255 (2)
20	WX-255	WX-255	WX-302	WX-255 (2)	WX-255 (2)	WX-302 (2)
25	WX-255	WX-350	WX-350	WX-255 (2)	WX-350 (2)	WX-350 (2)
30	WX-350	WX-350	WX-255 (2)	WX-350	WX-350 (2)	WX-302 (3)
35	WX-350	WX-255 (2)	WX-255 (2)	WX-350 (2)	WX-350 (3)	WX-350 (3)
40	WX-255 (2)	WX-255 (2)	WX-302 (2)	WX-350 (3)	WX-350 (3)	WX-350 (3)

The Effective System Protection (ESP) reduces system wear and energy consumption by keeping pump starts to a minimum. Larger Tank = Fewer Cycles = Longer Tank and Pump Life.

THERM-X-TROL® Quick Sizing

Maximum Temperature Setting 140°F				Maximum Temperature Setting 160°F				Maximum Temperature Setting 180°F			
Water Heater Size (gals.)	Static Supply Pressure (psig)			Water Heater Size (gals.)	Static Supply Pressure (psig)			Water Heater Size (gals.)	Static Supply Pressure (psig)		
	40	60	80		40	60	80		40	60	80
Tankless & POU up to 2 gal.	ST-1	ST-1	ST-1	40	ST-5	ST-5	ST-12	40	ST-12	ST-12	ST-12
40	ST-5	ST-5	ST-5	50	ST-5	ST-12	ST-12	50	ST-12	ST-12	ST-12
50	ST-5	ST-5	ST-12	60	ST-12	ST-12	ST-12	60	ST-12	ST-12	ST-25V
60	ST-5	ST-12	ST-12	80	ST-12	ST-12	ST-25V	80	ST-12	ST-25V	ST-25V
80	ST-12	ST-12	ST-12	120	ST-12	ST-25V	ST-25V	120	ST-25V	ST-25V	ST-25V
120	ST-12	ST-12	ST-25V								

Sizing based on: 40°F incoming water temperature; 150 psi T&P safety relief valve; Precharge equal to static supply pressure (ST-5 and above). ST-1 for Tankless and Point-Of-Use (POU) Heaters up to 2 gallons. For larger applications: Visit amtrol.com, download the AMTROL App or contact Technical Support at 401.535.1216.

EXTROL® Quick Sizing

Boiler	Type of Radiation			
	Finned Baseboard or Radiant Panels	Convectors or Unit Heaters	Radiators Cast Iron	Baseboard Cast Iron
Net Output in 1000'S of BTU/Hr.	Use Model	Use Model	Use Model	Use Model
MBH	Use Model	Use Model	Use Model	Use Model
25	EX-15	EX-15	EX-15	EX-15
50	EX-15	EX-15	EX-30	EX-30
75	EX-30	EX-30	EX-30	EX-60
100	EX-30	EX-30	EX-60	EX-60
125	EX-30	EX-60	EX-60	EX-90
150	EX-30	EX-60	EX-90	EX-90
175	EX-60	EX-60	SX Series	SX Series
200	EX-60	EX-90	SX Series	SX Series
250	EX-90	EX-90	SX Series	SX Series
300	EX-90	SX Series	SX Series	SX Series

Sizing based on: 12 psig Fill; 30 psig Relief Valve; 180°F Average Temperature. For sizing with fluids other than water: Visit amtrol.com, download the AMTROL App or contact Technical Support at 401-535-1216.

QUICK SIZING



PRODUCT	MODELS	DURATION (from date of purchase)
WATER SYSTEMS		
Well-X-Trol® Residential Well Tanks	WX	Seven (7) Year Limited Warranty
Well-X1® Constant Pressure System	WX1	Seven (7) Year Limited Warranty (Tank) Two (2) Year Limited Warranty (Control)
CH, WF & PL Well Tanks	All	Five (5) Year Limited Warranty
Guardian CP® Digital Control	DC2	Two (2) Year Limited Warranty
Reverse Osmosis (RO) Tanks	RO	Five (5) Year Limited Warranty
Amtrol Pressuriser®	RP	Two (2) Year Limited Warranty
PLUMBING & HEATING		
Extrol® Expansion Tanks	EX, RX & SE SX	Seven (7) Year Limited Warranty* One (1) Year Limited Warranty
Fill-Trol® Expansion Tanks	FT	Seven (7) Year Limited Warranty
Thermal Expansion Tanks	ST-1 through ST-12 ST-25V through ST-210V T	Seven (7) Year Limited Warranty* One (1) Year Limited Warranty One (1) Year Limited Warranty
Diatrol®	All	Five (5) Year Limited Warranty (Residential)
HOT WATER MAKERS®		
BoilerMate® Hot Water Makers	CH	Six (6) Year Limited Warranty on Heat Exchanger and Tank Assembly Only. Limited Lifetime Upgrade Option Available. See Literature for Upgrade Information.
HYDROMAX® Hot Water Makers	HM	Seven (7) Year Limited Warranty on Heat Exchanger and Tank Assembly Only. Limited Lifetime Upgrade Option Available. See Literature for Upgrade Information.
Ener-G-Net™ Control		Two (2) Year Limited Warranty
Digital Control Replacement		Two (2) Year Limited Warranty
Premier™ Hot Water Makers	WH-7, WHS, DC & S	Five (5) Year Limited Warranty in Commercial Applications. Ten (10) Year Limited Warranty in Residential Applications on Heat Exchanger and Tank Assembly Only.
ALL OTHER		
All Other Products, Components and Parts	If not specified above including Hot Water Maker components and parts other than the Heat Exchanger and Tank Assembly.	One (1) Year Limited Warranty

For detailed warranty information, please visit www.amtrol.com

All dimensions and weights listed are approximate.

*Units manufactured January 1, 2019 or later.

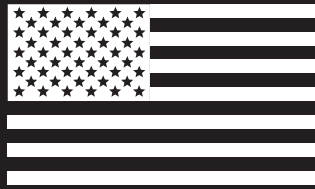

Committed to American Workers



MAKERS OF BETTER

Worthington Industries, Inc.
1400 Division Road, West Warwick, RI USA 02893
T: 800.426.8765 www.amtrol.com